

20 04

ANNUAL

REVIEW

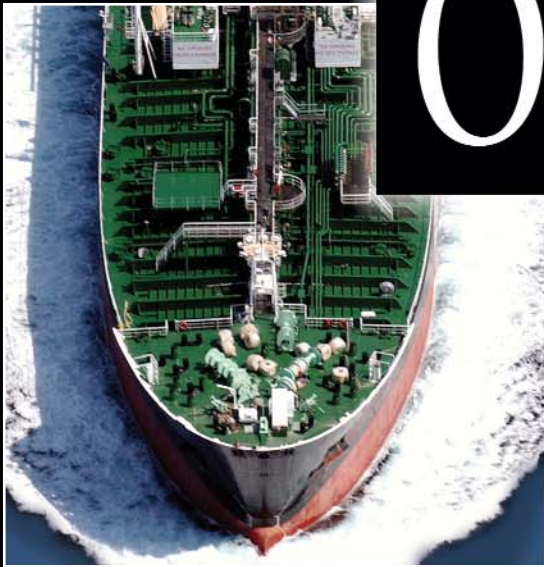

MISSION

The mission of the American Bureau of Shipping is to serve the public interest as well as the needs of our clients by promoting the security of life, property and the natural environment primarily through the development and verification of standards for the design, construction and operational maintenance of marine-related facilities.

QUALITY & ENVIRONMENTAL POLICY

It is the policy of the American Bureau of Shipping to be responsive to the individual and collective needs of our clients as well as those of the public at large, to provide quality services in support of our mission, and to provide our services consistent with international standards developed to avoid, reduce or control pollution to the environment.

All of our client commitments, supporting actions, and services delivered must be recognized as expressions of Quality. We pledge to monitor our performance as an on-going activity and to strive for continuous improvement.

We commit to operate consistent with applicable environmental legislation and regulations and to provide a framework for establishing and reviewing environmental objectives and targets.





TABLE OF CONTENTS

Chairman's Message	2
Marine Activity	6
Offshore & Energy Activity	10
Military Activity	16
Operations	20
Technology Achievements	30
Class Activity	38
ABS Corporate Officers	52
ABS Board & Council	54
ABS Worldwide Locations	56

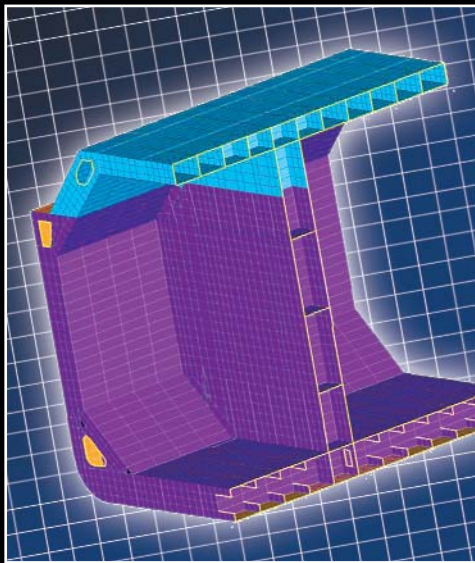



CHAIRMAN'S REPORT

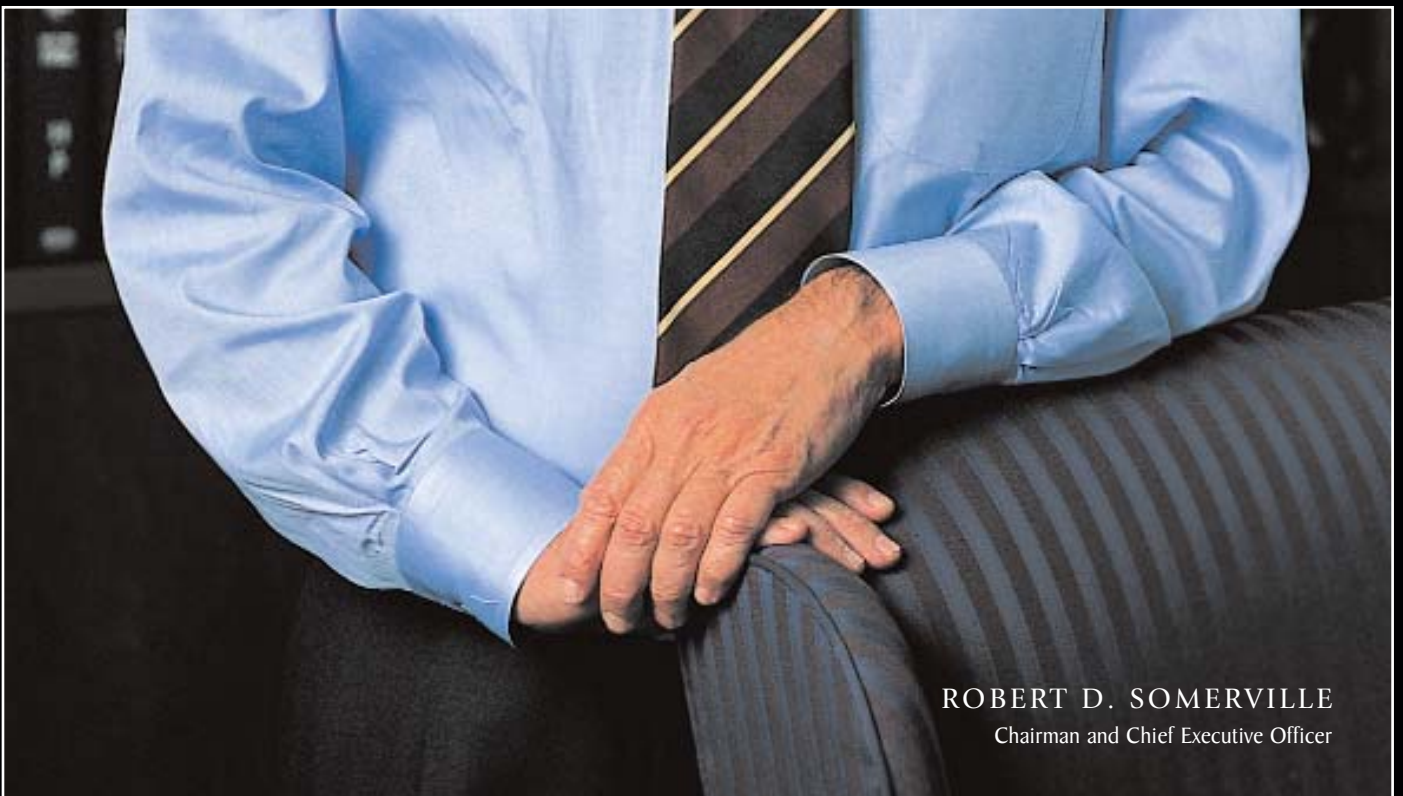

ROBERT D. SOMERVILLE
Chairman and Chief Executive Officer

R

arely in the modern history of the shipping industry have participants enjoyed such bountiful times as occurred in 2004. Owners of tankers, bulk carriers and containerships all experienced a sustained period of high rates. Shipbuilders, although faced with the rapidly escalating cost of steel, were able to increase new construction prices to remunerative levels in response to the continuing strong demand for ships of all types and sizes.

As one of the leading providers of classification services, ABS benefited from this remarkable level of activity. The ABS fleet grew steadily by 3.8m gross tons to a new record of 114.4m gross tons, a figure that solidified our position as the third largest class society. This fleet growth occurred as a result of strong deliveries of new ships, built to ABS class, coupled with a sharp downturn in scrapping as owners kept older vessels trading to reap the rewards of the very favorable rates on offer.

The buoyant market meant that ABS continued its recent history of solid financial performance, generating a surplus from operations that was in proportion to our not-for-profit status and that adequately funded both our extensive research projects and our global pension liabilities.

Yet, satisfying as this operational and financial performance may have been, underlying strategic and policy issues continued to pose challenges, not just for ABS but for the classification profession as a whole. Principal among these concerns is the exposure of the class societies to potentially ruinous unlimited liability.

In the aftermath of the *Prestige* incident, which has given rise to unwarranted legal action against ABS by the Spanish government, this society finds itself at the forefront of efforts to establish a more rational approach to classification society liability.

It is unsupportable that an owner and the flag State are both able to limit their liability arising from a marine casualty or incident, yet class societies are not afforded this same degree of reasonable protection. It is particularly disturbing that certain flag States require a class society that acts for them as a Recognized Organization to accept unlimited liability for its actions as an agent of the State, while the State itself is able to hide behind sovereign immunity.

In calling for a reform of this unjust system, ABS is not seeking absolution for its actions. We stand ready to be held accountable. But the reckoning must be appropriate to the fees charged and there must be an acceptance of the fundamental precept that a class survey is reliant on the honest personal and professional judgment of the surveyor concerned.

Efforts by certain governments to criminalize the actions of seafarers in 2004 rightly met with vigorous and outspoken industry opposition. No such outcry was mounted on behalf of the class

surveyor. Yet ABS personnel have found themselves, and will continue to find themselves subject to criminal action unless this entire issue of the role, responsibilities and potential liabilities of class is addressed by the industry as a whole, including the principal government jurisdictions that exert undue influence over maritime affairs.

This issue is of vital importance to ABS and to class. But it is not the only issue that needs to be addressed by industry and government. Throughout the year, classification continued to be criticized by a wide range of interests, including owners and legislators, for perceived failures to meet its responsibilities. A fairer definition would be that these critics perceived class as failing to meet their expectations.

ABS strives mightily to fulfill its responsibilities but cannot meet the constantly expanding expectations of these critics unless and until the role and responsibilities of class are redefined and clarified by our industry and legislative partners.

Never has there been a more appropriate time to embark on such a broad re-evaluation of the services expected of class than now, given recent developments. Class responsibilities have already been expanded away from our traditional engineering-based activities to include safety and security management system audits. Change in the governance of class is being enforced by the European Union, wanting reassurance of the true independence of class from any one sector of the industry, most notably from shipowners. And 2005 will hopefully see the adoption by all IACS societies of new, common rules for tankers and bulk carriers, representing the most fundamental change in the rule-making function of class since its inception.

Historically, class societies have competed on the basis of the strength of their technical competence, the superiority of their service delivery and the competitiveness of their pricing. With the adoption of common rules for tankers and bulk carriers, and the expected expansion of the common rule approach to containerships, machinery and other areas, the issue of technical competence of any one society will greatly lessen in importance. The result will be greater emphasis on service, to the benefit of owners and shipbuilders, and on price, to the detriment of class and potentially of safety.

As with any business, class is not immune to competitive pricing pressures. Within reason these spur innovation and efficiencies. Left unchecked, however, there is a strong possibility that standards, and therefore safety, may suffer. The mission of ABS is promoting the security of life, property and the natural environment. This mission would be placed at risk if the expected enhanced focus on price and service should lead to unremunerative pricing of the services offered.

To prepare for this new competitive environment, ABS accelerated the development of several internal projects that will allow us to deliver more comprehensive classification services more efficiently, thereby controlling the cost of those services.

These programs have targeted all operational and administrative aspects of our activities including engineering and survey services and financial management. Significant administrative savings have already been realized as a result of the new software systems that have been introduced to assist the field surveyors. Increased productivity and faster plan approval will be realized once the new engineering support software is fully implemented. And new financial service centers have been established that have already realized significant cost savings.

The projects have required an unwavering commitment of personnel and money over an extended period to realize the actual and projected efficiencies. Important as they are, they are no more than the most obvious tactics adopted by ABS in its never ending efforts to improve the quality and responsiveness of the services provided to our customers.

Whether it is through the formation of client-oriented project teams within our engineering departments or increased training for our surveyors, ABS is committed to providing the most professional, most responsive and most customer-centered services possible. To do that, it is essential that we listen to our clients and respond to their needs.

Even greater emphasis was placed on this aspect of our activities in 2004. Conversations with clients identified several areas that call for innovative thinking and the development of new approaches; responses that are already under way.

Responsible shipowners are demanding more of their class societies. Where it is within our existing area of responsibility, ABS will continue to strive to meet those expectations. But more can and should be done to solidify effective self-regulation of this industry through a redefinition of classification society responsibilities. ABS will continue to work with its class colleagues, with its clients, with the major industry associations and with the IMO and individual government entities to encourage this much needed debate.

A handwritten signature in black ink, reading "Bob Somerville". The signature is written in a cursive, flowing style.

Robert D. Somerville
Chairman and Chief Executive Officer

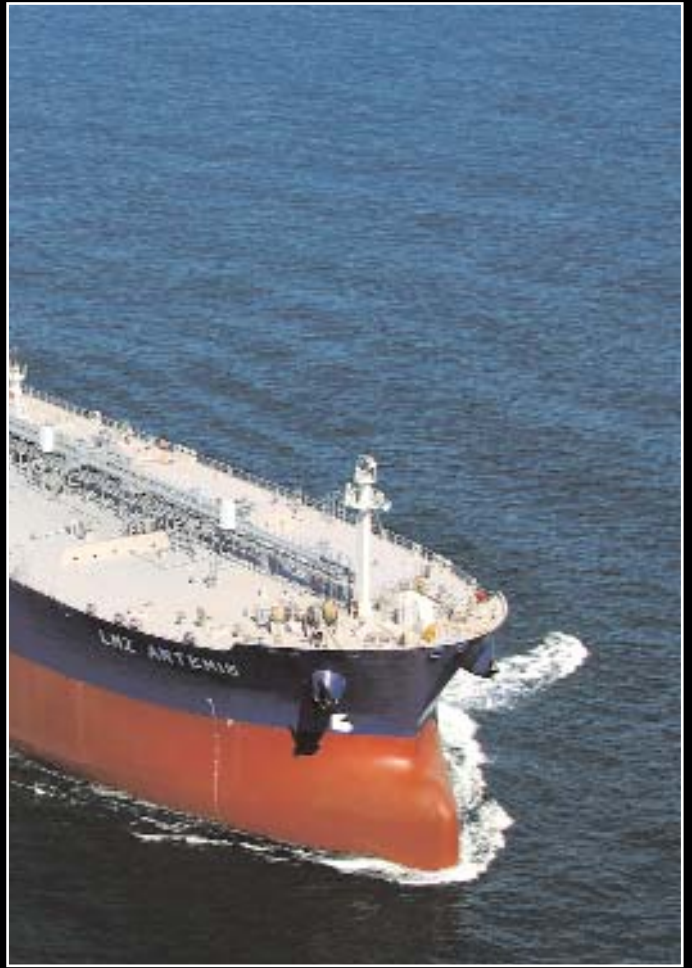

MARINE ACTIVITY

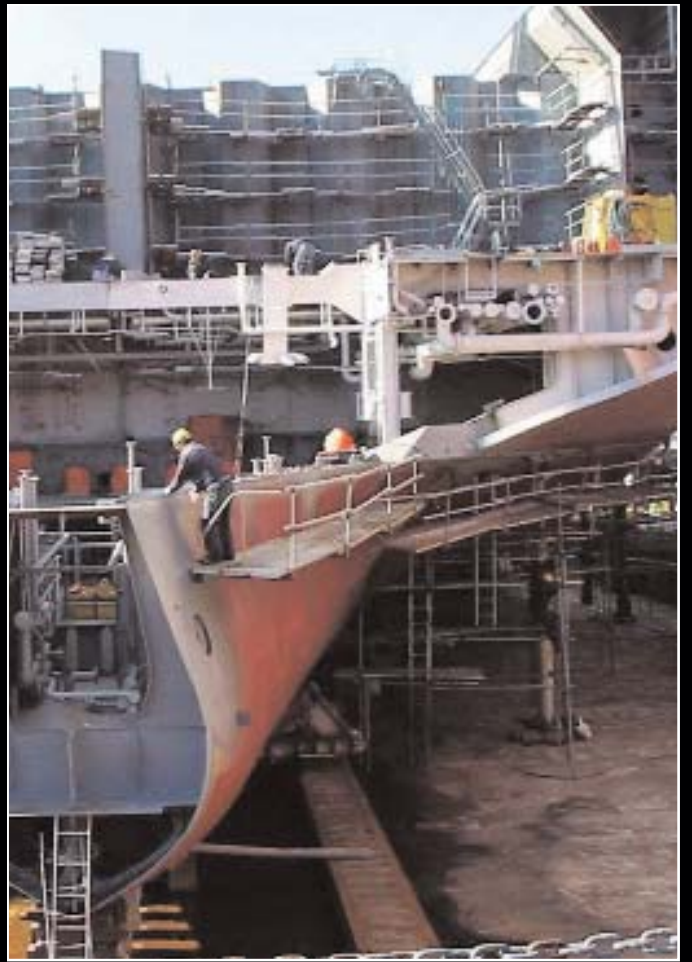

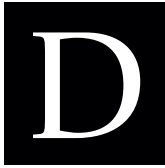

emand for classification services ebbs and flows with the wider market tides that influence the international shipping industry. Those tides were in full flood during 2004 as a remarkably buoyant and prolonged surge in demand for ships of almost every type and size kept the world's shipyards full and ABS engineers and surveyors busy.

Adding to this heightened level of activity was the implementation of several new IACS standards and regulatory requirements that required compliance within relatively short time frames. These included such diverse elements as a reassessment of the structural strength of existing single hull bulk carriers, to the implementation of the new International Ship and Port Facility Security Code for which ABS provided auditing services on behalf of 50 flag Administrations.

It was a year in which clients demanded responsive service to meet accelerated production schedules at the shipbuilding yard and quick turnaround from shiprepair yards as new ships were hurried into service and downtime for existing vessels was minimized whenever possible. ABS geared up to meet these challenges by allocating its engineering and survey resources in the most effective manner, by working with clients to develop pragmatic responses to their operational and regulatory responsibilities and by introducing improved administrative processes aimed at speeding plan approvals, streamlining the survey support processes and simplifying documentation.

The net result was what will appear as an extraordinary year within the 142-year history of ABS. The ABS-classed fleet grew strongly by 3.5 percent to a new record of 114.4m gt. The number and aggregate tonnage of all vessels on order to ABS class also reached record levels at almost 1,000 vessels aggregating 19.3m gt representing a near 15 percent increase of 2.5m gt over a year earlier. Revenues also rose to a new record high and a concerted effort to restrain expenses through the introduction of administrative efficiencies resulted in a sound financial performance that leaves the society well positioned for the future.

At the close of the year the ABS-classed fleet stood at 9,230 vessels and offshore facilities, an increase of 139 vessels and 3.8m gt over the prior year. The continued dominance of tankers, bulk carriers and containerships within the ABS fleet can be noted with these categories accounting for 87.5m gt of the total. This comprised 2,078 vessels and represents a steady increase in number and tonnage over 2003.

Tanker contracts continued to dominate the new construction orderbook. At the close of 2004 ABS retained a market-leading 28 percent of all tankers on order at shipyards around the world. This included a 30 percent share of all VLCC tonnage on order and a 38 percent share of all contracted suezmax tonnage. Over the course of the year, ABS received contracts to class 122 new tankers, representing 5.3m gt. Among the new tankers contracted were 18 VLCCs, 22 suezmaxes and 57 aframaxs, contributing to a year-end orderbook of 362 tankers of 8.3m gt. In all, 77 new tankers of 4.8m gt were accepted into ABS class in the year bringing the ABS tanker fleet to 798 vessels aggregating 46.6m gt.



Bulk carrier activity also remained strong in 2004 with 54 new bulk carriers aggregating 2.0m gt entering ABS class. This represented a significant increase from the 2003 figure. Among the new bulk carriers classed were 8 capesizes, 27 panamaxs, 5 handymaxs and 19 handysizes. At the close of the year, the fleet of ABS-classed bulk carriers remained stable at 683 vessels aggregating 22m gt as several vessels reached the end of their service life and were scrapped.

Competition for containership orders remained distorted in 2004 due to the significant impact of German fiscal policy on ship finance and a preference for German finance houses for investments in the containership market. Despite the continuing negative impact on the participation of ABS within this traditionally strong market segment, 20 new containerships of 1.1m gt, including the then largest vessels in service, were accepted into class by the Bureau. This mirrored the level of activity of the previous year and allowed ABS to maintain its overall market share. At the end of 2004, the ABS-classed fleet of containerships numbered 423 vessels aggregating 15.8m gt.

In addition to the acceptance into class of more than 150 existing vessels during the year, either as a result of a change of class or reinstatement, ABS classed 482 newly-built vessels aggregating 9.2m gt in 2004. The new vessels represented a steady increase in gross tons and number over the previous year. Of even greater importance for the future stability and growth of ABS, contracts for the classification of 598 new vessels of 9.8m gt were received at a steady rate throughout 2004. This level of activity was similar to the previous year in terms of tonnage contracted but represented a significant 51 percent increase in the number of contracts which spiked sharply upward by 202 vessels from the previous year's total of 396.

Included in this total were contracts to class 214 new tankers, bulk carriers and containerships totaling 7.7m gt. The contract figures for all types of new vessels continued to remain well ahead of historic ordering patterns of the previous decade. ABS was particularly successful in winning

large series contracts from owners placing orders for smaller vessels, below 20,000 dwt, the majority of them coastal tankers for service in European waters. Greek owners were particularly active in this sector. Turkish owners also turned to ABS for class on series of both small feeder containerships and for the small tankers, many of them from Turkish yards. More than 30 percent of all tonnage on order from Turkish shipbuilders at year's end was to ABS class. Engineering capability was added to the ABS Istanbul office to improve service to both Turkish owners and shipyards.

Italian and German-based owners were also very active in the newbuilding market in 2004. Although both have a national society available to them, a significant number sought the services of ABS. The ABS fleet of ships either in service or on order to German owners grew to 3.3m gt by year's end. And the ABS share of newbuilding orders placed by Italian owners grew to more than 30 percent, principally tankers, product and chemical carriers.

Greek owners remained staunch supporters of ABS throughout the year, further extending a long and valued relationship. Tankers and bulk carriers remained the mainstays of Greek contracting. Representing a notable breakthrough, ABS was also selected to class two 145,000m³ LNG carriers ordered from DSME for Maran Gas, a new entrant into the rapidly growing LNG sector.



LNG remained a focal point of new ordering activity in 2004 with the first orders being placed to meet the needs of the huge Qatar gas development projects. By the end of the year the ABS orderbook for LNG carriers had grown to 27 vessels, representing a 26 percent market share, for Asian and European owners from builders in Korea, Japan and China. The Chinese orders from Hudong shipyard will be the first LNG carriers to be built by that nation's rapidly expanding shipbuilding sector.

Encouraging as these positive fleet growth figures were, the quality of the ABS-classed fleet was of paramount importance. Port State performance records were scrutinized closely to identify potential problem vessels. Particular attention was paid to high-risk vessels, so deemed because of their age and type. Over the course of the year, class was cancelled on 334 vessels for non-compliance with the ABS Rules. The combination of the strong deliveries of new vessels and the elimination of many older vessels, either by scrapping or cancellation of class resulted in a further reduction in the age of the ABS fleet.

By year's end, more than 50 percent of the entire ABS-classed fleet was comprised of vessels of no more than 9 years of age, measured in gross tonnage terms. With the accelerated phase out of single hull tankers set to begin in 2005, this age profile is expected to show further improvement in coming years.



OFFSHORE & ENERGY ACTIVITY



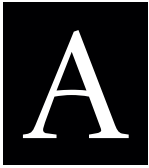

ABS is the leading provider of classification and certification services to the global offshore and energy sectors. More than 520 offshore exploration units of all types, 250 production units (including fixed platforms), almost 100 gas carriers and over 1,000 offshore support and service vessels are in ABS class, are contracted to be built to ABS class or have been certified by ABS. The combined experience and knowledge of ABS engineers and surveyors with such a wide range of ships, vessels, units and facilities meant that demand for ABS offshore and energy-related services remained at a very high level in all three operating divisions throughout 2004. Governments also turned to ABS, seeking to tap into this vast pool of experience.

From working with the designers of a third-generation cell spar design to undertaking engineering review of a massive semisubmersible facility that will serve as a gas gathering hub for six fields with peak gas production estimated at 850 million cubic feet per day, ABS played an important role throughout 2004 in the development and application of new technologies and innovations that have long characterized offshore exploration and production activity.

While the traditional offshore sector remained busy throughout the year, it was the production, storage and transportation of natural gas that captured industry's attention. The global market for liquefied natural gas (LNG) and its associated terminal facilities increased in 2004 at more than three times the growth rates for traditional gas and oil markets. With 50 years of experience in the transportation of LNG, ABS was well positioned to capitalize on the opportunities that arose.

As the year drew to a close, 27 LNG carriers were on order at shipyards in Korea, China and Japan to ABS class with many more orders pending as the enormous Qatar gas projects continue to unfold. Both experienced LNG carrier operators and new entrants to this rapidly expanding sector turned to ABS for guidance including such prominent owners as British Gas, Malaysian International Shipping Corp. (MISC), K-Line, the 3-J and 4-J consortia and Maran Gas among others.

LNG TECHNOLOGY

Contributing to this success was the extensive technical research into the safe transportation of LNG that was undertaken by ABS. This research focused on fatigue life for the new generation of very large LNG carriers – upwards of 200,000m³ – and the effect of sloshing within partially-filled membrane cargo tanks. ABS also collaborated with a leading Korean shipbuilder in undertaking advanced research into the effect of vibration, excited by the expected switch to slow speed diesel power plants for these new large LNGs, on the membrane cargo containment system.

Associated research focused on the technical challenges of designing, building and maintaining offshore LNG terminals and related facilities that are expected to handle the majority of the future increase in LNG movements. The terminal development requires a comprehensive approach toward the integration of marine

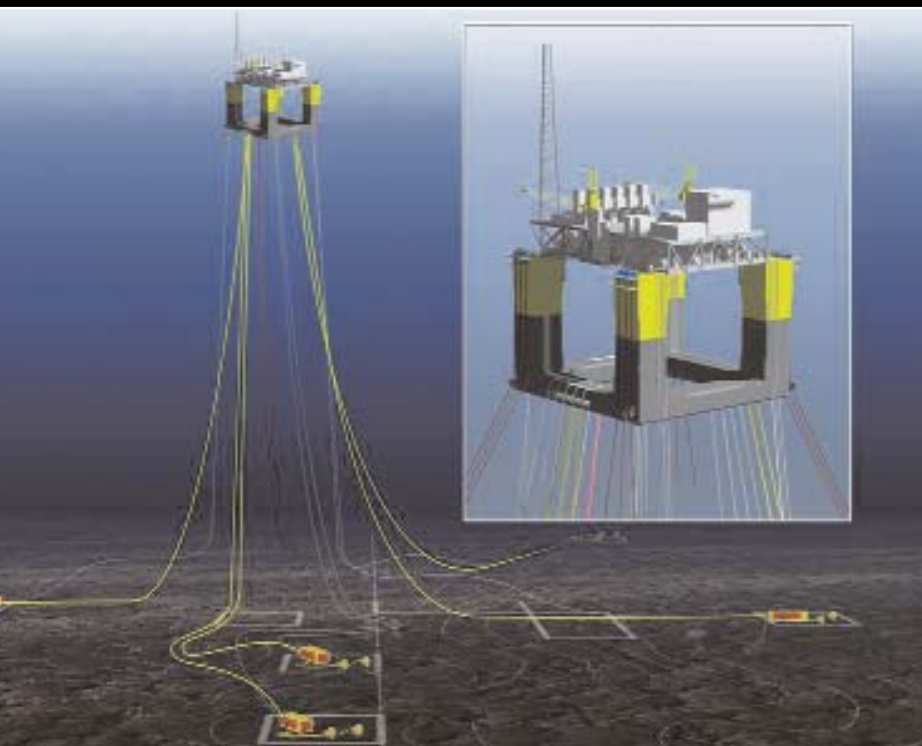

and shore-based gas handling and processing facilities in designs that may be either gravity-based or floating. Issues to be considered include analysis of the containment system of floating terminals when partially-loaded and the relative motion between the terminal and LNG carrier during loading and offloading operations.

Detailed knowledge of the US and global regulatory arena by ABS personnel, and an understanding of

the risks associated with the transportation, storage and handling of LNG, further enhanced the level of service available to operators faced with public concern over the safe handling of LNG, both on land and offshore.

ABS also issued Approval-in-Principle (AIP) to a new LNG tank containment system and carrier design developed by US-based Ocean LNG, Inc. The proposed 180,000m³ carrier design features five large 36m diameter and 40m-high cylinder tanks each with a capacity of 36,000m³. As part of its AIP process, ABS evaluated the overall tank and vessel design including the containment system and structural strength, the tank support system and midship section scantlings and conducted a stability analysis, hull form and speed calculations and hydrodynamic analysis.

The proposed concept was so sufficiently different from existing designs that ABS engineers utilized risk assessment as part of the review process, based on the standards in the recently released ABS *Guidance Notes on Review and Approval of Novel Concepts*, to determine if the design provided levels of safety comparable to current industry practice.

AIP was also awarded to a leading energy major for a new proprietary LNG tank design featuring a unique trapezoidal shape that reduces free surface area thus reducing the high impact sloshing loads and resonance period in the tank. Model tests and application of ABS proprietary numerical simulation tools predicted the dynamic and sloshing pressures that confirmed the design was within load limitations.

ABS' participation in the Energy Bridge Deepwater Port project demonstrated the application of offshore technology (traditionally used in the offloading of oil and liquid products) to gas transfer in a marine environment. ABS contracted with Advanced Production and Loading AS (APL), of Norway to provide classification services for its Submerged Turret Loading (STL™) system, an integral component of the Energy Bridge project. The project, located in the Gulf of Mexico, will be the first offshore LNG deepwater port terminal in the world.

AN INDUSTRY PARTNER

Along with this extensive research effort, ABS aligned itself with organizations dedicated to the safe transport of LNG and the education of the public with respect to this energy source. ABS was the first classification society accepted into associate membership status by the Society of International Gas Tanker & Terminal Operators (SIGTTO). As the year came to a close, ABS announced it would support the education and training of seafarers on LNG carriers through its involvement with SIGTTO, in cooperation with the International Association of Maritime Universities (IAMU).

In 2004, ABS also became a member of the American Petroleum Institute's Center for LNG. And ABS Chairman and CEO Robert D. Somerville was appointed to the National Petroleum Council, an oil and natural gas advisory committee to the US Secretary of Energy.

Helping to advance the pioneering nature of exploration and production activities, ABS participated in the work of the US-based Offshore Energy Center and supported the Offshore Technology Research Center (OTRC), a US National Science Foundation (NSF) Engineering Research Center supporting the offshore oil and gas industry. ABS also became a member and supporter of the Center for Marine Compressed Natural Gas, a joint partnership between industry and the Memorial University of Newfoundland in Canada.

SUPPORTING VIABLE ALTERNATIVES

Throughout the year, ABS supported innovation in another gas-to-market technology, compressed natural gas (CNG). Working with industry, ABS further refined its pioneering *Guidance Notes for Building and Classing Ships Carrying Compressed Natural Gas*. Using these standards, and those contained in its *Guidance Notes on Review and Approval of Novel Concepts*, ABS granted Approval-in-Principle to the

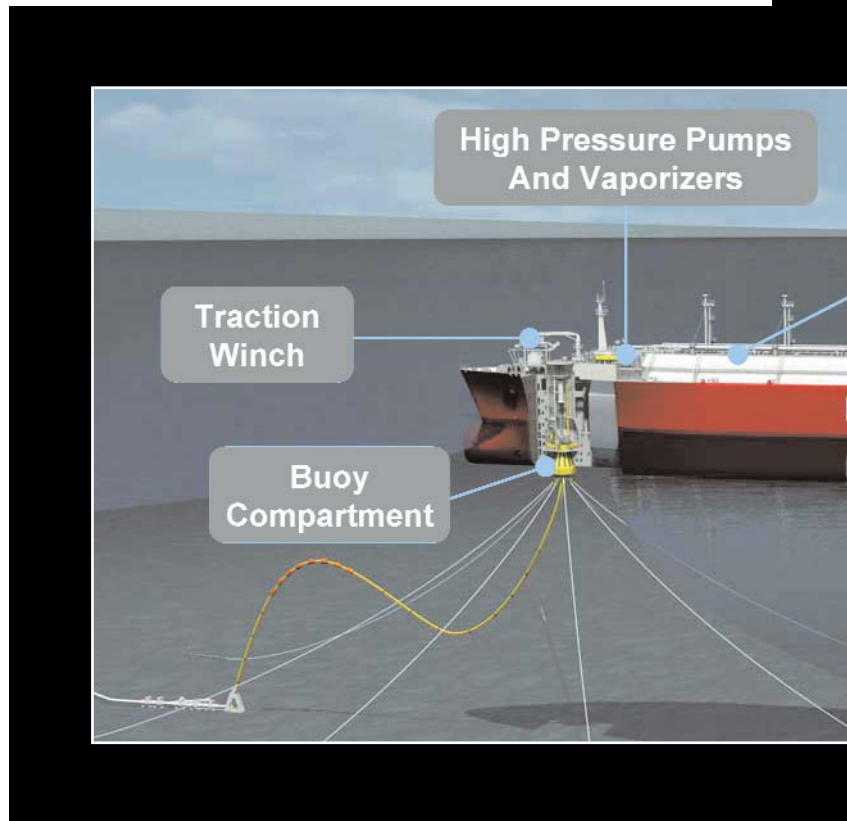



CNG containment systems developed by EnerSea Transport LLC and Trans Ocean Gas. Two other CNG containment designs, the GTM approach utilized by TransCanada and the Coselle system were subject to extensive engineering review and acceptance by ABS.

Another notable first was the delivery by Japanese builders to ChevronTexaco of the ABS-classed *Sanha LPG FPSO*, the first such vessel to enter service. The LPG production facilities include gas separators, gas refrigerators and boil-off gas reliquefaction units. ABS is the only class society with large ship experience with the Ishikawajima Harima Heavy Industries (IHI) developed self-supporting prismatic IMO Type-B cargo containment system selected for the unit.

NOTABLE DEVELOPMENTS AND PROJECTS

A Memorandum of Understanding (MOU) with the Agency of the Republic of Kazakhstan for Emergency Situations that represents the Kazakh Coastal State Authority was signed by ABS in 2004. The MOU established a formal framework for technical collaboration between the two organizations with respect to offshore oil and gas operations in the Caspian Sea.

Placing itself at the center of energy activity in the Middle East, ABS announced the establishment of a new Middle East Regional headquarters in Doha, Qatar, as the year came to close. By locating the administrative and commercial functions for the entire region to Doha, ABS strengthened its ties to the energy sector, particularly the growing production and shipment of LNG from Qatar.

In the Gulf of Mexico, spar innovator Kerr-McGee selected ABS for classification of its *Constitution* truss spar. This represented the sixth spar ABS will class for the operator. Kerr-McGee has pioneered this concept with three generations of ABS-approved designs: classic, truss and cell. Another notable project in the region was the Mississippi Canyon 920 Independence Hub, a semisubmersible facility designed for 8,000 feet of water. The ABS-classed platform, to be owned by Independence Hub, LLC, an affiliate of Enterprise Products Partners, L.P., and operated by Anadarko Petroleum, will serve as a gas-gathering hub for several nearby fields.

During the year, ABS awarded class for the Rowan Companies Inc.'s *Scooter Yeargain* jackup, the first of four in a new series of the Le Tourneau Tarzan Class designed to drill deep gas wells down to 40,000 feet in shallow waters. The Tarzan Class is a lighter-weight version of Rowan's ABS-approved Gorilla and Super Gorilla Class designs. Significant developments also occurred on the ABS-classed *Thunder Horse* and *Atlantis* projects, semisubmersible production facilities being built for operation by BP in 6,500 feet of water in the Gulf of Mexico.

In Brazil, the development of the Barracuda and Caratinga fields passed a milestone as the first of the two oil tankers converted into floating production, storage and offloading (FPSO) vessels took up position in the Campos Basin. The ABS-classed *Barracuda FPSO*, P43, has a storage capacity of 2 million barrels of oil. The second FPSO, the ABS-classed *Caratinga FPSO*, P48, was due to enter service early in 2005.

ABS was selected to provide class services for the proposed *Capixaba FPSO* servicing Petrobras' fast-track Golfinho field development near the Espirito Santo Basin. The field features the region's most prominent light crude and natural gas discovery to date. Other ongoing FPSO conversion projects for Brazil include contracts for the P50 (*Albacore Leste FPSO*) and the P54 (*Roncador 3 FPSO*). To strengthen survey services to offshore clients in Brazil, ABS also opened a new survey station at Macae.



ABS increased its service to operators involved in the rapid development of West Africa's energy resources by opening an office in Douala, Cameroon. Staff numbers were increased in Angola to further improve survey delivery in the region. Approximately 280 offshore supply vessels, 35 drilling units and 15 FPSOs operate to ABS class in the West African region. Under discussion are a number of new FPSO projects, including the largest such unit to be purpose-built, that are scheduled to come on line in the near future.

The year proved very successful for ABS within the offshore and energy sectors, not only in terms of the numbers and wide scope of energy projects that were won by the society in a highly competitive market but also for the technical innovations and service delivery improvements that ABS implemented to meet the rapidly changing demands of this dynamic sector.



BMT Nigel Gee and Associates Ltd.

MILITARY ACTIVITY



Northrup Grumman Ship Systems



Naval classification and certification activity undertaken by ABS accelerated during 2004. The ABS *Rules for Building and Classing Naval Vessels* were formally authorized by the recently formed ABS Naval Technical Committee for application to naval combatant acquisition programs. With that major advancement, ABS classification work began on the first US Navy combatants to be classed.

ABS now has project teams applying these Rules on various naval vessel projects ranging from the new Land Attack Destroyer (DD(X)) to the high speed Littoral Combat Ships (LCS). In addition, ABS is engaged in specific system certification work on the LPD-17 amphibious support ship and the LHD-8 air-capable amphibious support ship.

To successfully support this burgeoning naval activity, ABS implemented a focused organizational restructuring of its Government Operations Office in 2004. A Government Program Management Structure was created, providing dedicated Program Managers for each government project. A Naval Engineering department was formed to focus on technical support for government work.

The groundwork for ABS' expanded role in the establishment of standards for military vessels was solidified in 2003 with the signing of the formal Cooperative Agreement with the Naval Sea Systems Command (NAVSEA) under which the joint development of the new ABS *Naval Vessel Rules* was accomplished. With completion of the Rules in 2004, commercial processes have been successfully merged with naval technical requirements to produce a ship classification approach specifically tailored to the needs of the military. These new Rules follow the release of the similar, jointly developed ABS *Guide for Building and Classing High Speed Naval Craft* that was released in the preceding year.

Immediate application of the *High Speed Naval Craft Guide* occurred when the Office of Naval Research (ONR) looked to ABS for plan approval and survey of its advanced X-Craft (now named *Sea Fighter FSF-I*), a high speed aluminum catamaran, to be delivered in 2005 for operation under the Commander Naval Surface Forces Pacific. The X-Craft will be the first vessel to be designed, constructed and subsequently operated to these new standards. ABS has also provided similar support for the *AMH SeaCoaster* a 31.2 meter surface-effect catamaran with an advanced hull form technology that has been patented by the ONR.

Additionally, the Naval Surface Warfare Center (NSWC) Carderock Division requested ABS technical support and input on classification requirements for a new Rapid Strategic Lift Ship (RSLs). This ship will be a relatively high speed vessel with a unique hull form.

Other activity included the request from the US Navy for ABS to certify the pressurized rescue module and the launch and recovery system for the new submarine rescue diving and recompression system (SRDRS). This is being developed as the next generation rescue system for the crew of submarines in distress. Associated with this, ABS is chairing the NATO working group that is considering unified



certification processes for all such submarine rescue systems worldwide to maximize interoperability among the navies of the world which operate submarines.

Navies from other nations also sought assistance from ABS in 2004. The Egyptian government's Fast Missile Craft (FMC) Program and Fast Patrol Craft Program called for a series of high speed, highly maneuverable vessels to be built to ABS class. The government of

Oman has specified ABS class on a series of patrol craft it is building in the United States. In addition, the Mexican Navy has the first four of what is expected to be a longer series of patrol boats building to ABS class.

Support for the US Coast Guard's Deepwater program continued in 2004 with ABS providing selected certification for the first Maritime Security Cutter, *Large (WMSL)*, otherwise known as the *National Security Cutter*. This support included both engineering plan review and survey attendance. A further USCG Deepwater project undertaken by ABS involves review of various specialized patrol boat designs. ABS is also providing survey support to the Coast Guard team building the *Great Lakes Icebreaker (WAGB)*.

In addition, discussions with the Coast Guard continued exploring the application of the ABS *Naval Vessel Rules* to the follow-on Deepwater assets – the Maritime Security Cutter, *Medium (WMSM)* and the smaller Patrol Cutter (WPC). To lay the groundwork for this, the US Coast Guard Engineering Logistics Center took the lead in a partnership with ABS to develop the US Coast Guard Addendum to the ABS *Naval Vessel Rules*.

Work for the US Military Sealift Command (MSC) in 2004 focused on keeping this fleet of logistical supply vessels operating in support of US forces in Iraq, Afghanistan and other regional assignments. Quick response engineering review and survey services were provided to keep the vessels in service.

New construction classification work for the MSC continued on the T-AKE, a ship that MSC will operate as an advanced dry cargo delivery vessel in support of deployed forces. Planning has begun for three new MSC vessels that will also be classed by ABS. These are the T-AOE(X) Battlegroup Support Ship, the Maritime Prepositioning Ship Future (MPF(F)) and the T-AGM(R) vessel, a new construction missile range instrumentation ship used to monitor international compliance with strategic arms treaties.

The US Army Tank Automotive and Armament Command (TACOM) engaged ABS to class the Logistics Support Vessels (LSV) being built at a US Gulf Coast yard. The first of these vessels will be used to keep US Army personnel supplied with intratheater transfer of equipment and supplies. TACOM plans to introduce a fleet of Theater Support Vessels (TSVs) in the near future, the design of which will be developed in partnership with the US Navy High Speed Connector Program. These high speed vessels will be ABS classed. In addition, ABS engineering offices supported TACOM with plan review and survey of extensive modifications to its fleet of oceangoing tugs.

The new Fisheries Research Vessels, classed by ABS for the US National Oceanographic and Atmospheric Administration (NOAA), neared completion in 2004. Work was begun on a new SWATH vessel for the government agency that will be used in oceanographic research. Also in 2004, ABS developed a comprehensive inspection process for NOAA that complements class surveys by providing a framework for assessing the status of all systems fitted on NOAA ships.

The long standing support provided by ABS to the US Army Corps of Engineers continued in 2004 through the society's involvement with several of the Corps' vessel programs. Through Boeing, ABS supported the Missile Defense Agency by providing classification review of the new SBX platform, a Mobile Offshore Drilling Unit converted to carry a large X-Band Radar for application in the Strategic Defense Initiative missile defense program. This vessel will be retained in class during operation.

This unprecedented level of involvement by ABS in an ever widening range of government and military programs for the US and other nations is expected to continue and expand in 2005. By working collaboratively with the various government forces, departments and agencies ABS has engendered a growing level of trust and confidence in the ability of class to efficiently provide a very high level of technical services that fully meet the highly specialized needs of their essential programs.



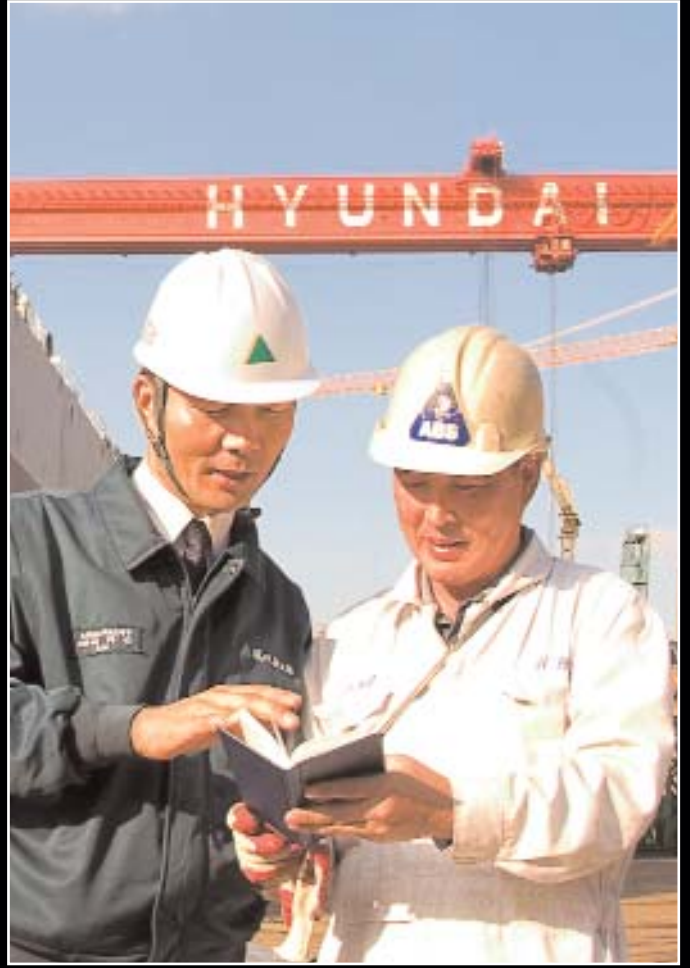

OPERATIONS



T

he overriding focus of all operational activities throughout 2004 was on the provision of improved customer service through the development of more efficient, responsive delivery systems. Superior service and administrative efficiency have always been strategic objectives of ABS. However, pending changes in the traditional structure of classification have given new impetus to the application of innovative thinking to the challenge of further improving service and service delivery if ABS is to continue to differentiate itself within a highly competitive market.

Over the past year, several multi-year, multi-million dollar advanced information technology projects were either completed or entered into the final stages of testing and implementation to improve survey, engineering and financial services. In each instance, ABS believes that the result is, or will soon be the provision of the most advanced, responsive yet easy-to-use systems available, to the benefit of both clients and ABS staff members.

Providing clear evidence of the impact these developments have had on overall efficiencies is the fact that ABS has been able to significantly increase the number of surveyors and engineers to meet the demands of a steadily increasing fleet, without any need to increase support staff. In fact an overall 3.5 percent reduction in employee numbers was experienced in 2004 as the efficiencies of the various new systems were realized, even though the ABS-classed fleet increased by 3.8m gt and the orderbook of new ships booked to ABS class rose to record levels.

At the same time, service delivery significantly improved. For example, significant progress was made towards providing clients with real time access to survey reports with some reports now being made available within hours of the last visit. One year ago, the time was measured in days. Five years ago the measure was weeks. These operating efficiencies have also been consistently passed on to clients by limiting fee increases to well below average prevailing inflation levels. Over the last ten years, the year-on-year increase has been held to an average of less than 1 percent, reflecting the significant cost reductions of delivering client services.

SURVEY ACTIVITIES

Heightened new construction activity at shipyards in almost 40 countries and the requirement from clients to minimize survey downtime for existing ships operating in a rare bull market, placed heavy demands on the more than 700 ABS surveyors stationed around the world. This demanding workload was further accentuated by changes in international regulations and IACS requirements for certain ships, particularly bulk carriers that required close oversight by the survey team. The international regulatory environment and class rules themselves are now more restrictive and more stringently applied than at any time before.

ABS has responded by taking a multi-faceted approach to these new demands. This requires heightened interaction between the survey department and the clients, keeping them informed of these changes and



advising on practical implementation strategies; a more collaborative approach to developing rapid, proactive and pragmatic solutions to problems identified on board a ship or rig during survey; and an aggressive training program for the surveyors themselves to help them fully understand both the meaning and the application of the regulatory and Rule changes.

This latter aspect was addressed in 2004 with the most active training

program ever undertaken by the Bureau. Using a combination of courses held at the ABS Academy in Houston, at various divisional and field offices and through an expanded on-the-job mentoring program, ABS worked hard to educate surveyors at all levels, from entry to the most experienced, including an extensive revalidation program.

Every one of the ABS worldwide team of surveyors will have been through a competency revalidation course within a two-year period ending third quarter of 2005 and will then be required to repeat the training at specified intervals going forward. Specialized training courses were also developed to meet specific needs, the most prominent being an extensive course on the survey of construction of LNG carriers of all containment types to meet the recent surge in orders.

Appropriate training and procedural responses were also developed in preparation for the pending implementation of new regulations in 2005, in particular the MARPOL Annex VI limitations on polluting emissions, and the pending IMO-mandated Condition Assessment Scheme (CAS). Buttressing the overall training program was an expanded level of field support as the Divisional Lead Surveyor program, instituted in 2003, matured. These very experienced surveyors were available to assist port offices undertaking difficult or specialized surveys, to provide activity monitoring to further promote consistency in the delivery of ABS survey services at all ports around the world, and to provide direct mentoring to newer surveyors or to those surveyors looking to expand their knowledge of a particular ship type.

Field operations continued to benefit from information technology and electronic transmission and storage of survey requirements, survey reports, certificates and client invoices. Survey status data files were further improved, while the amount of regulatory and vessel-specific information made available to both customers and surveyors continued to increase.

These achievements reflected the collective experience of a specially selected team of field subject matter experts, drawn from within the ABS organization to specify, test, train and implement the related applications, processes and procedures. Returned to field locations, these experts now serve as a source of local knowledge and product vision.

As has been repeated on many occasions before, ABS considers the record of ABS-classed vessels inspected by port State authorities worldwide to be the best public validation of the success of its surveyor training and the dedication of its field staff. Although final 2004 figures from the principal port State bodies (Paris, Tokyo and the US Coast Guard) have yet to be released, preliminary indications are that they will reconfirm ABS as one of the elite class societies as determined by this measure.



ENGINEERING ACTIVITIES

ABS engineers, located in 14 offices around the world, provide front line service to clients in both the shipbuilding and shipowning sectors. A great deal of effort was expended in 2004 to provide these engineers with an improved operating environment that will lead to a step change in the speed of response to client needs and the degree of client interaction in the plan review process. The new systems will also offer significant overall administrative efficiencies.

These improvements stem from the development and phased implementation of the most advanced electronic system currently possible for the submission, review and approval of vessel drawings. The system will bring together electronic submission of all drawings by the client; the application of the ship-specific Rule and regulatory requirements, drawn from the rapidly expanding electronic ABS Rules database; electronic embedded Rule calculation routines; and real time interaction and collaboration with the client to address specific issues identified during the review. The entire review process, from acceptance of the drawings to final stamping and invoice creation will be handled electronically.

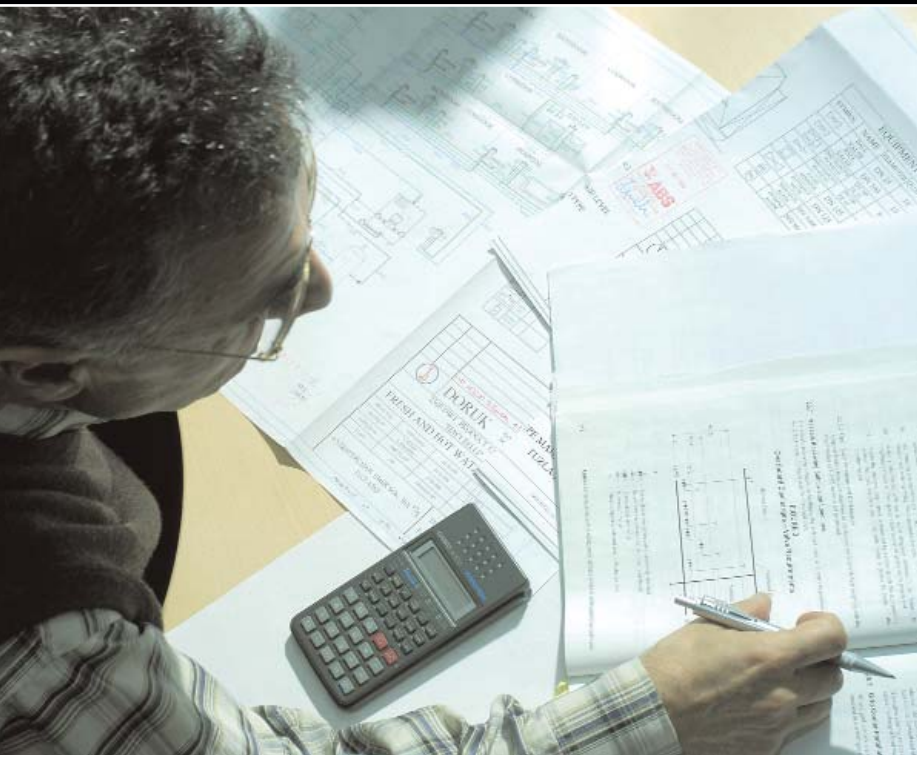

The first elements of this ambitious modernization of traditional engineering work practices were implemented in 2004 with second phase elements under beta testing by year end for early implementation in 2005.

A reorganization of the engineering teams in the principal engineering offices was undertaken, realigning responsibilities to match the new system. The reorganization places a strong emphasis on a project-based structure,

specifically tailored to improve communication with clients. Once fully implemented, a routine plan review and approval that has traditionally taken several weeks is expected to be completed within days bringing the class review process into line with the accelerated design development processes of the major shipbuilders.

The new system also offers lifecycle benefits to shipowners as all technical and statutory information relating to each ship will be electronically captured at the outset and can be made available through the ABS SafeShip system. SafeShip provides the means to record and analyze the entire history of the vessel, its structure and its machinery in addition to all relevant survey information.

These system improvements have been, and continue to be seamlessly implemented during a period of unprecedented activity for the ABS engineering staff as the newbuilding order spree continues. In addition, 2004 presented additional engineering challenges including ship-by-ship analysis of the implications of the new IACS S31 structural requirements for existing bulk carriers; analysis of the impact of the proposed new common rules for tankers and bulk carriers; assessment of various novel design concepts, particularly for offshore and gas projects; extensive analysis of proposed ultra large containership designs and of the new generation of very large LNG carriers; the continuing complex conversions of existing tankers to FPSO configurations; and the development of informational seminars for clients on subjects as diverse as ice class requirements to new bulk carrier Rules.

Particular attention was given to assigning appropriately qualified staff to the rapidly expanding engineering office in Shanghai. With orders for ABS-classed vessels flooding into Chinese shipyards, the office continues to play a critical role in not only reviewing plans for these new designs but also assisting the many design offices at the new Chinese shipyards as they develop a rapidly growing portfolio of plans for different ship types and sizes.

In addition, a new engineering office was established within the ABS Istanbul, Turkey office during 2004. Owners turned to Turkish shipyards to fill orders that could not be placed with acceptable delivery dates from overflowing Asian yards. Offering plan review and direct assistance to shipyards in Turkey, the new office met with immediate strong client support for its responsiveness.

SAFETY, ENVIRONMENTAL AND SECURITY ACTIVITIES

ABS experienced a high level of demand for its Safety, Environment and Security Certification (SESC) services in 2004. The most significant activity was focused on the new implementation of the International Ship and Port Facility Security Code (ISPS) requirements. Under this new IMO initiative, all vessels of 500 gt and upward engaged on international voyages were required to implement a Ship Security Plan and train identified shore and shipboard personnel to carry out the plan by 1 July 2004.

The Code requires that the Ship Security Plan be reviewed by the flag Administration, or its delegated Recognized Security Organization (RSO), to verify conformance with the Code. Such approval is to be followed by a successful audit of the vessel by the flag Administration or the RSO prior to issuance of an International Ship Security Certificate (ISSC). ABS received authorization from more than 50 flag Administrations in 2004 to perform this work on their behalf.

In the period leading up to the July deadline, ABS SESC conducted a series of seminars in the major shipping centers to inform clients of the ISPS requirements to help them prepare for the daunting task of meeting the new standards within an accelerated timeframe. To meet these new demands, ABS SESC identified and trained over 250 members of the ABS global surveyor workforce to take on the additional responsibilities of a Maritime Security Auditor.





These auditors and the SESC corporate and divisional staff reviewed and approved over 1,700 Ship Security Plans and certified and issued over 1,800 International Ship Security Certificates in time to meet the deadline. The highly proactive and cooperative approach of the ABS SESC team drew numerous accolades from flag Administrations, shipowners and ship managers.

Although the ISPS Code requirements placed an extraordinary burden on the ABS SESC staff, ISM certification activity continued throughout

the year. Previously certified vessels required intermediate and renewal audits and verifications in 2004. Additionally, port State authorities requested that ABS conduct additional audits on several vessels to verify their continued compliance with the ISM Code.

A variation on the organization's traditional ISM auditing activity in 2004 was forged from an alliance between the Bureau and the American Waterways Organization (AWO) which represents tug and barge operators working within the domestic US trades. These vessels and operators are not bound by the International Code but the AWO implemented a similar management system certification program, the Responsible Carrier Program (RCP), applicable to its members. ABS has been approved to conduct the necessary audits for certification to the RCP.

The RCP is an industry-led, self-regulatory process. 2004 saw the US Coast Guard and the Towing Safety Advisory Committee, responding to a Congressional directive, instigate the development of a mandatory safety management system standard for the US inland and coastal waterways industry. The SESC professionals at ABS are working closely with industry and with the USCG assisting with the development of this new standard.

TYPE APPROVAL

The ABS Type Approval Program gained momentum in 2004 achieving new records for client enrollment and broadening its reach to more than 5,000 models of products, mainly within the categories of valves, marine cables, diesel engines, pumps, packing material and davits for life and rescue boats.

As important as the program's growth was the demographics of this growth with many manufacturers in Europe and Pacific seeking approval for their products. ABS Type Approval provides product certification that is recognized worldwide, recognition that is considered a business advantage by many manufacturers.

Manufacturers sought Certificates of Type Approval to demonstrate their products can be produced consistently and to applicable standards. Certification under the ABS Type Approval Program includes design evaluation of the product, prototype testing and annual surveillance and monitoring of the manufacturing process.

Growth in the ABS Type Approval program throughout 2004 meant further strengthening of the program's processes, particularly of the applicable database capabilities and refinement of the dedicated ABS Type Approval web site. Web traffic tripled from the previous year as users, particularly European-based users, searched the database of type approved products or accessed the advanced certificate printing capability.

INFORMATION TECHNOLOGY

To remain competitive and deliver superior client services, ABS continued to introduce new elements of its carefully orchestrated information technology (IT) strategy throughout 2004. This strategy is designed to establish business models that can provide the lowest cost, most responsive service delivery, and classification-related product models that capture and present in useable formats all the data essential for the lifecycle maintenance of a vessel, from drawing board to scrapyards.

Reference to several of these IT developments, those that affect engineering services and survey delivery, has already been made within this Review. These are critical elements within the overall IT enterprise architecture. But, to be effective, they must be and are integrated with and supported by many other elements ranging from financial processes and reporting to human resource files.

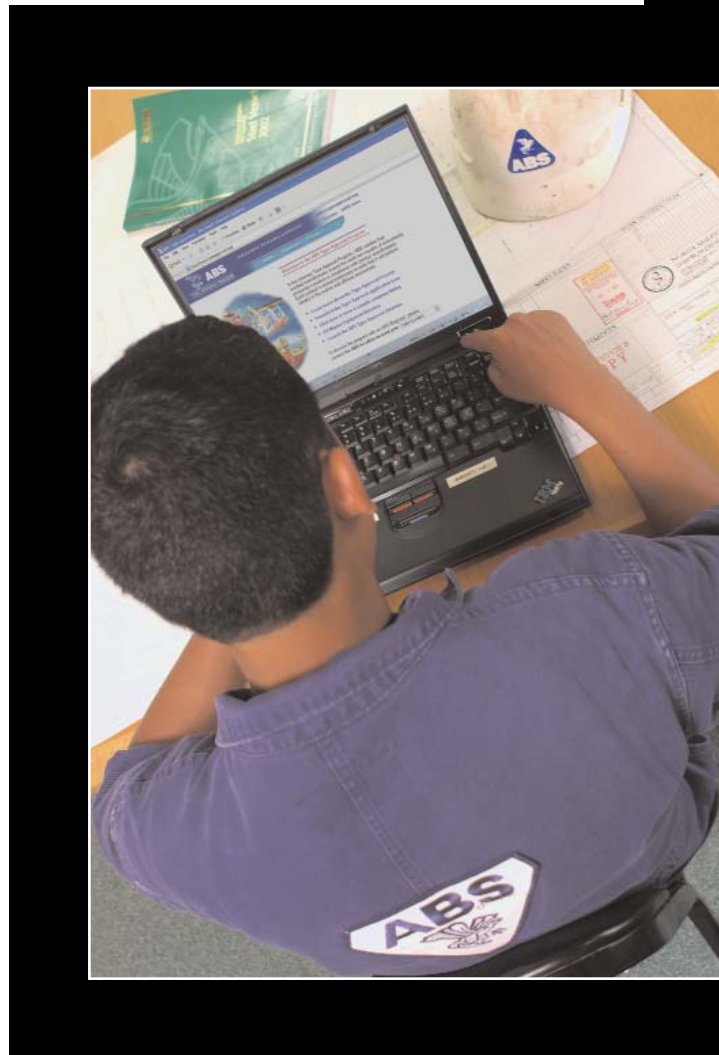



This enterprise architecture has replaced a number of previous, separate systems and has returned dramatic improvements in the quality of the services offered by ABS, the speed of delivery of those services, the administrative efficiency of the organization and the management tools available to optimize allocation of resources, particularly manpower.

By fully utilizing the extensive software

capabilities, located in India, of the ABS affiliate, ABS InfoLink Inc., and by forging relationships with prominent vendors such as Intergraph Corporation, significant steps were taken in 2004 to extend the capabilities of this IT architecture. An aggressive implementation schedule was established at the start of the year and all principal targets were met. Further refinements were identified and the development of this sophisticated information platform that underpins the entire operation of ABS, its products and services will be continued in the coming year.

ORGANIZATIONAL CHANGES

Stability and continuity have been fundamental characteristics of ABS throughout its 143-year history. These core values were clearly in evidence in 2004 with the retirement of long serving ABS Chairman and Chief Executive Officer Frank J. Iarossi and the passing of those responsibilities to Bureau veteran Robert D. Somerville. The handover was part of a carefully planned transition strategy that will see further changes as a generational shift in the management of ABS is phased in over the next five years.

On assuming the Chairmanship of ABS, Somerville became just the eleventh individual to hold that prestigious position in the organization's history. In so doing, he vacated the position of President and Chief Operating Officer that he had held since 1993. Taking over those responsibilities for the day-to-day operations of ABS was Robert E. Kramek, formerly President and Chief Operating Officer of the Americas Division. Representing the new generation of future leaders of the Bureau, Todd W. Grove was appointed President and COO of ABS Americas.

Two other long serving, key members of the ABS management team also retired in 2004, Dr. Donald Liu, Executive Vice President and Chief Technology Officer, and Gus Bourneuf, Vice President and Chief Surveyor. Both had distinguished careers within the Bureau and had won industry-wide recognition for their contributions to marine safety. Replacing them were Christopher J. Wiernicki and Linwood (Lenny) Pendexter respectively.

Several other changes within the divisional and regional management structures were made during the course of the year as part of the overall succession and transition strategy. Opportunities for advancement were created for employees throughout the organization to encourage continuous invigoration of ABS activities.

ABS is constantly seeking to refine the allocation of its most valuable resource, the more than 1,600 dedicated, multi-national employees who operate from offices in 70 countries, to best meet the needs of our clients. New offices or survey stations were established in Manaus and Macae in Brazil, and in Douala, Cameroon. A new Middle East commercial and administrative headquarters was established in Doha, Qatar to better serve our energy-based clients in the region. Also established was a new engineering department within the ABS Istanbul, Turkey office to improve service delivery to Turkish shipyards and owners.

ABS activities in China continued to grow throughout the year as orders for ABS-classed vessels flowed into Chinese shipyards and Chinese repair yards increased their market share. ABS engineering and survey staff numbers in China were judiciously increased to meet both the immediate needs and to prepare for expected future rapid growth of marine activity in the country.

Administrative efficiencies were introduced throughout the organization over the year as the benefits of the previously mentioned IT systems took effect. Wherever possible affected staff members were reassigned to other duties or reductions were achieved through attrition.

All of these management and administrative changes were accomplished smoothly without disruption to day-to-day activities or service delivery and left ABS solidly positioned for the future.

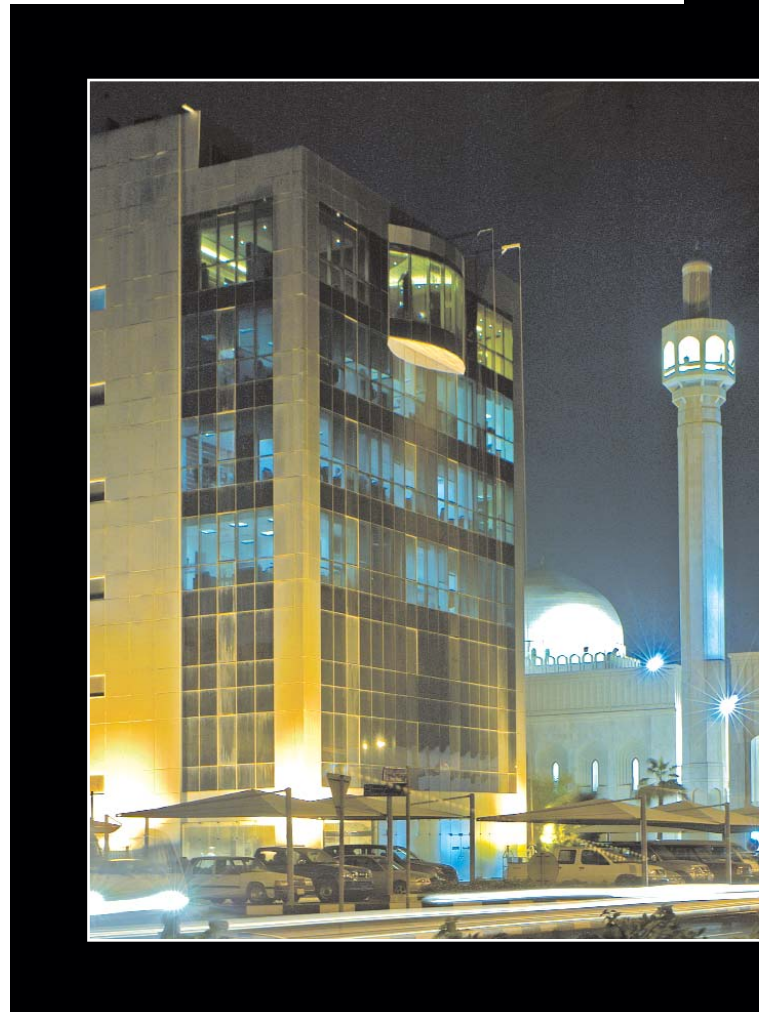

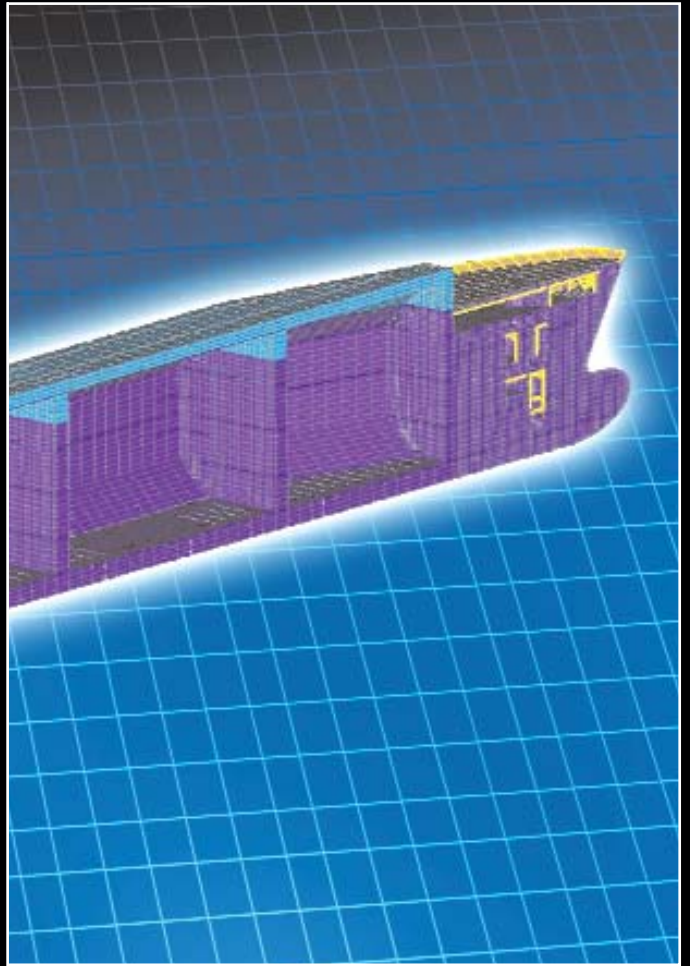
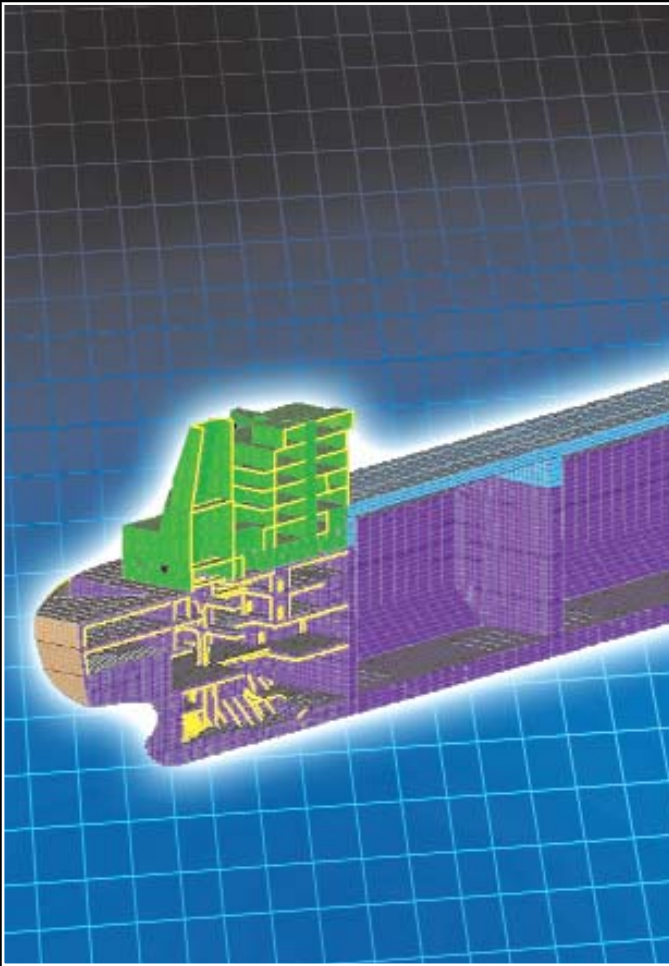

TECHNOLOGY ACHIEVEMENTS

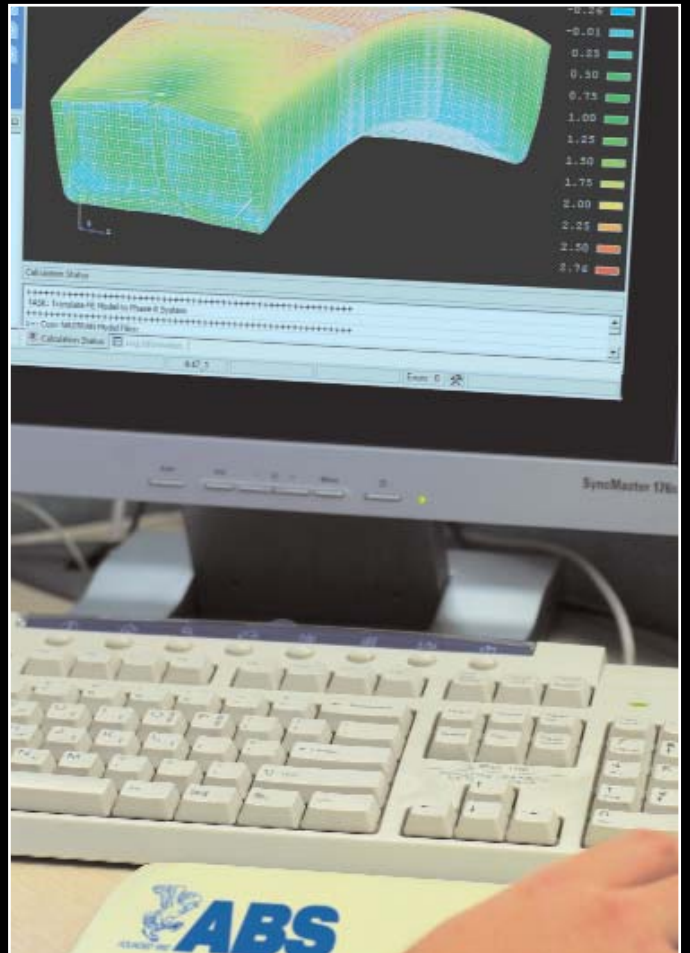

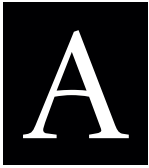

broad spectrum of issues was addressed by the ABS Technology group in 2004 as staff members pursued advanced research projects in response to industry concerns. These ranged from ABS participation in the development of new IACS common rules for tankers to research into the leading indicators for safety that predict root causes of risk that can lead to marine accidents. Each of the projects undertaken by the group, whether the development of a new Rule or Guide, or detailed research of a particular subject, was undertaken with a clear understanding of its contribution to the improvement of safety standards and of its immediate relevance to technical issues being faced by individual clients or the industry-at-large.

COMMON SCANTLING PROJECT

The joint project, undertaken by ABS, DnV and Lloyds Register to unify scantling requirements for double hull tankers of 150m and above represents a landmark change in the manner in which classification standards are established. Work on the project began in early 2002 and a draft set of the new standards, together with extensive explanatory background documents, was released to industry for comment in mid-2004. Numerous joint and individual industry presentations were made by the three societies in support of the release.

Industry response was overwhelmingly positive in principle. However, the extent and detail of the comments received from industry necessitated a deferment of the proposed adoption and implementation schedule so that proper evaluation could be undertaken. Ongoing rule development and calibration by applying the draft rules to a variety of existing designs continued, in addition to the assessment of the industry feedback. Extensive software result comparisons were undertaken to verify that the proprietary software of each of the three societies would return consistent results.

A new implementation schedule was agreed that required the release of a further draft of the proposed rules at the end of March 2005. A companion project being undertaken by the other seven members of IACS to develop common rules for bulk carriers followed the same timeline with the rules developed by both groups scheduled to enter into force 1 January 2006.

In preparation for this, the ABS Technology group developed software to aid shipbuilders in designing tankers in accordance with the new common tanker rules. Seeking simplicity and ease of integration with shipyard processes, the new software uses a state-of-the-art geometric modeller to develop an ideal hull model to which details, including longitudinal and transverse structures, stiffeners and plates can be added. Rule checks are run using a spreadsheet format. The software then uses a commercially developed automatic mesh interface to analyze the design. In late 2004, ABS was the first society to release joint tanker project software, including the finite element package to assist shipbuilders to fully assess the proposed rules. When adopted, the new rules will result in a new tanker design for which identical scantlings will be derived regardless of which society is selected to class the vessel.



RELATED DEVELOPMENTS

In a related project, considerable progress was made during 2004 towards the expansion of the intelligent databasing of all ABS Rules, Guides and relevant statutory requirements. The project is part of a carefully developed strategy to develop and integrate business and product models within an overall IT enterprise architecture.

Electronic access, using a web browser, is now available to all the principal steel vessel and offshore Rules by ABS engineers and surveyors. The system facilitates the generation of project specific check sheets and retrieval of all Rule and statutory requirements, linked to their specific process instructions.

A further project is developing embedded computerized calculation and evaluation capabilities for all vessel types that either will not be covered by the joint tanker and bulk carrier programs or are not otherwise addressed by ABS SafeHull. A prototype design of the system was developed in 2004 with implementation expected to be phased in over the coming year.

ENHANCEMENTS

Researchers within the Technology group are constantly seeking ways to further enhance both ABS standards contained in the Rules and Guides and the tools available to ABS engineers for evaluating the application of those standards. Notable enhancements completed in 2004 included the development of an enhanced application of the Dynamic Load Approach and Spectral Fatigue Analysis programs through the automation of additional processes that account for non-linear sea loads. ABS is the first class society to include consideration of non-linear sea loads within a full ship structural response model.

As industry interest has grown in the accurate and rapid assessment of fatigue in structures such as existing tankers earmarked for FPSO conversion, very large LNG carriers, ultra large container-ships and in aging tankers undergoing condition assessment, so too has the need for more sophisticated analytical tools. Through these developments, ABS believes it now has the most advanced proprietary tools available within the industry for the accurate assessment of fatigue.

A large number of ABS Rules and Guides were subject to revision and improvement during the year, many of them related to the technically-innovative offshore sector. These included a significant enhancement to the *ABS Guide for Building and Classing Floating Production Installations* through the inclusion of new standards for spars (the first such standards issued by a class society) and tension leg platforms (TLP), addressing global performance issues and motion characteristics such as vortex-induced vibration (VIV) loads. Considerable investigation was also undertaken into the structural hull strength and fatigue requirements for these vessels, using detailed feedback from industry, with the intent of refining current criteria.

Standards for the certification of fiber-reinforced plastic for hydrocarbon piping systems were also subject to significant revision and enhancement with a new Guide issued that expands and replaces the criteria previously contained in an appendix to the *Floating Offshore Installations Guide*.

Of particular interest to industry and ABS in 2004 was the development of an appropriate technical and engineering approach to the growing fleet of aging jackups. In addition to responding to specific client queries, ABS issued a detailed technical Commentary to its *Rules for Building and Classing Mobile Offshore Drilling Units* as a further step in providing industry with more precise direction on the application of these Rules.

ABS also issued *Guidance Notes on Dynamic Analysis Procedure for Self-Elevating Drilling Units* that were developed in response to industry concerns that the dynamic wave-induced response be fully considered at the design stage. When used in conjunction with the *ABS MODU Rules*, the new Guidance Notes provide criteria, guidance and acceptable practice for conducting dynamic analyses and classification review of jackup structures.

Several other Rules and Guides relating to offshore structures were either released or updated in 2004. The *Guide for Buckling and Ultimate Strength Assessment of Offshore Structures* provides a set of stand-alone structural criteria for achieving optimum levels of structural safety for offshore units. It uses the largest existing test database of component failure as a reference point to benchmark the new buckling formulas. An update to the *ABS Guide for Building and Classing Offshore LNG Terminals*, the first such standards to be released to industry, was issued during the year. The update reflected the rapid development of these concepts by industry to meet a surge in demand for new LNG terminals.



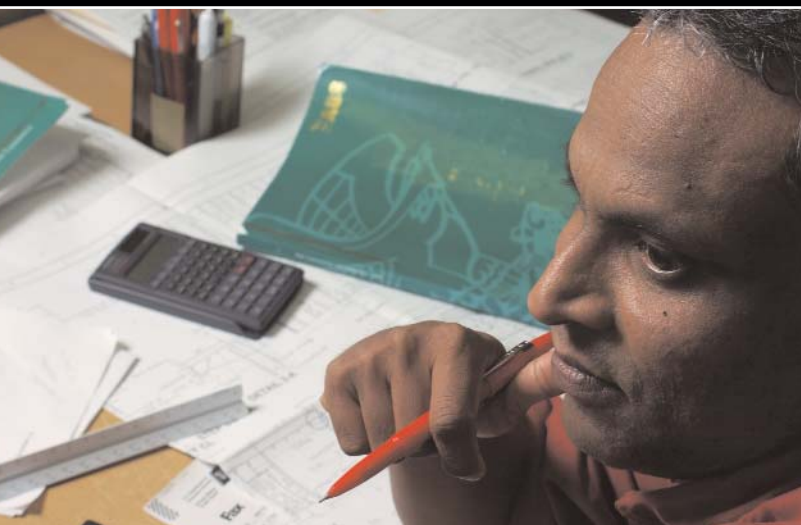

Other updates and commentaries addressed certification of drilling systems, building and classing subsea pipeline systems including LNG subsea pipelines, the building and classing of subsea riser systems and the application of the SafeHull system to FPSO structural analysis and fatigue assessment of offshore structures.

Another project led to the updating and separation of the previous criteria for building and classing subsea pipelines and risers into two standalone

Guides. Enhancements to the subsea pipeline criteria included recommendations for subsea cryogenic LNG pipelines, and the introduction of the latest ASME design requirements among others. The riser criteria were expanded to include design and material considerations for flexible risers and ancillary components, including fatigue life.

Additional guidance for ABS design review engineers, for surveyors and for industry was developed with respect to propulsion shafting alignment. The new criteria, and associated software, apply the most advanced evaluation techniques to this issue which is growing in importance with the continuing size increase in certain ship types, particularly the development of ultra large containership designs.

Industry demand for new aframax and suezmax tanker tonnage built to operate in ice in the Baltic and off Sakhalin Island, stimulated further research into ice loads to determine if additional guidance could be offered to industry. The result was the development of *Guidance Notes on Nonlinear Finite Element Analysis of Side Structures Subject to Ice Loads* to assist clients in developing alternative, more produceable structural arrangements acceptable to the Finnish Maritime Administration's requirements, as an alternative to traditional prescriptive methods.

Several software tools were also revised and improved during 2004. These included placing the ABS WebCalc program on the ABS web site, making it available to all clients including shipyards and design firms. The program was initially launched only on the ABS intranet site for internal use. WebCalc was conceived to provide calculations for checking machinery against ABS Rule requirements. With its external release, calculations for the Rules for steel vessels under 90 meters were developed and added. Clients have been encouraged to use WebCalc when preparing designs for submission. By using the same calculation tool as the ABS engineer reviewing the project, the plan approval process can be greatly simplified and accelerated.

Also subject to enhancement in 2004 was the computational tool used to conduct propeller stress analysis. The latest version can be used for analysis of the blade strength of controllable pitch propellers and of propellers intended for use in ice in addition to fixed blade configurations. The program streamlines and shortens the time required to complete computational fluid dynamic and finite element method analysis of propeller blades.

RESEARCH PROJECTS

Numerous research projects are undertaken by the Technology group, many in cooperation with prominent academic institutions, with many of the world's most prominent ship-builders or as part of joint industry projects. In 2004 the most prominent studies focused on issues ranging from the understanding of parametric roll resonance on the design of containerships to a study of naval vessels in damaged condition.

The purpose of the latter project was to prepare procedures and tools to analyze naval vessel designs with particular focus on the dynamic response and loads. The project also considered high speed craft in the regime where dynamic lift may significantly alter the behavior of the vessel.

LNG containment systems were subject to several research investigations during the year, some ongoing. They included an analysis of sloshing loads, analysis of the loads on the pump tower, investigation into the impact of alternative propulsion systems on containment system vibration performance and evaluation of a novel tank design to determine if it would reduce sloshing impact pressure. Another study considered loads from a collision or grounding incident involving a large gas carrier. The LNG strength Guide was updated. And guidance on the requirements for dual fuel propulsion plants was issued for builders and operators.

Significant progress was made during the year on an extensive project to develop a method for the analysis of propeller cavitation and propeller-induced hull pressure as designers sought to reduce vibration associated with these forces. These issues have become more critical as demand for larger container, passenger and LNG carriers increases. Larger, faster vessels require more propulsive power which can translate into higher loads on propellers, increased vibration and vibration-related failures. Three sophisticated analytical software programs have been developed to date that address cavitation, water flow and induced hull pressure.



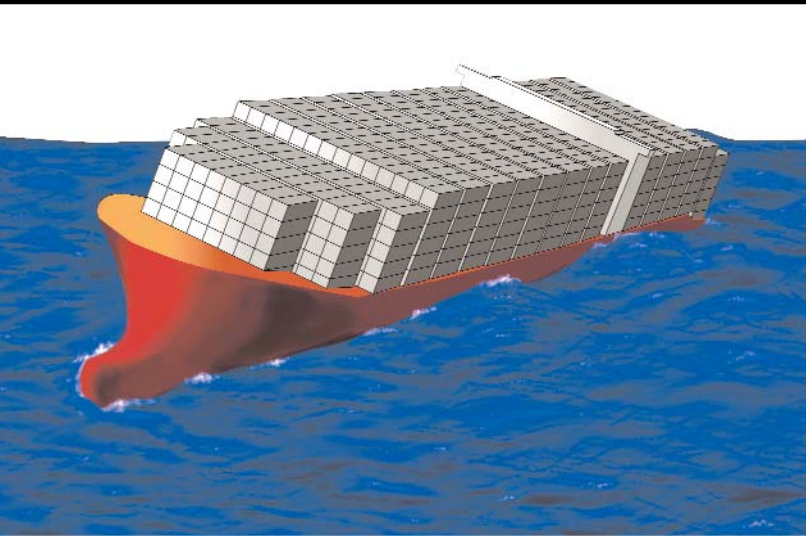

Increases in the size and speed of containerships have also focused attention on the likely incidence of parametric roll. Following extensive research, ABS issued a Guide for the assessment of a containership design's sensitivity to parametric roll in late 2004. In addition to the assessment techniques contained in the Guide, requirements for anti-rolling devices and specific operational guidance for crew members is also given.

Working in close collaboration with a leading operator, ABS also studied the implications of inerting ballast spaces on double hull tankers. A new Guide was released to industry as a result of this research.

RISK ASSESSMENT

The application of risk assessment methods to the development of marine classification standards continues to expand. Risk management can be used to improve safety, security and reliability, to assist in decision-making, to assess the safety performance of a new design and to comply with regulatory requirements in addition to demonstrating equivalency with classification standards. ABS encourages the use of risk approaches within its own organization as well as by design firms, shipyards and the owners and operators of ships and offshore facilities. Tools that have been developed by ABS to assist in this process include a risk management module within its overall ABS SafeShip lifecycle program, a reliability-centered maintenance (RCM) module and a risk-based inspection (RBI) module.

The risk management module is an easy-to-use software tool designed to facilitate the application of risk methodologies and helps users gather and manage qualitative risk analysis data. The objective of the risk-based inspection module is to assist in the development of survey and inspection plans for ship structures using risk-based principles. It draws on information contained in the hull maintenance module and on the results of structural assessments such as ABS SafeHull and provides for the prioritization of the structure in terms of criticality through the identification of the areas with the highest consequences should failure occur. A companion draft *Guide for Surveys Using Risk-Based Inspection for Ship Structures* was also prepared in 2004.

The maintenance philosophy referred to as reliability-centered maintenance is a technique that is being migrated into the marine sector from shore-based industries. By understanding the risk of

losses associated with equipment failure, a maintenance program can be optimized by allocating maintenance resources according to the risk impact on the vessel. With the application of RCM principles, maintenance is evaluated and applied in a rational manner that provides the most value to a vessel's operator through improved equipment and system reliability.

The ABS SafeShip reliability-centered maintenance module is a software tool designed to facilitate RCM analyses and helps users gather and manage the necessary data. Features of the module provide templates for various systems, databases with failure modes for various equipment parts, and databases sorted by equipment for various condition monitoring techniques. A companion *Guidance Notes on Reliability-Centered Maintenance* was also issued in 2004.

HUMAN FACTORS ENGINEERING

Industry continues to develop engineering responses to the challenge of improving maritime safety. These can range from double hull configurations to redundant equipment requirements. Yet it is unquestioned that human error is the single largest contributing factor to marine losses. In an effort to fully understand the impact of the human element within the safety equation, and to develop appropriate standards that address this, ABS is continuing a multi-year investigation into the application of human factors engineering to the marine environment.

Increased attention was paid to the development of an appropriate root cause analysis methodology to be used to fully investigate marine safety incidents. The method, developed with significant industry and governmental input through the US National Safety Council's Marine Division, provides a systematic approach to investigating, categorizing and determining root causes. Such a review increases the ability of a vessel's operator to recover from and prevent future incidents. Relevant software has been developed by ABS.

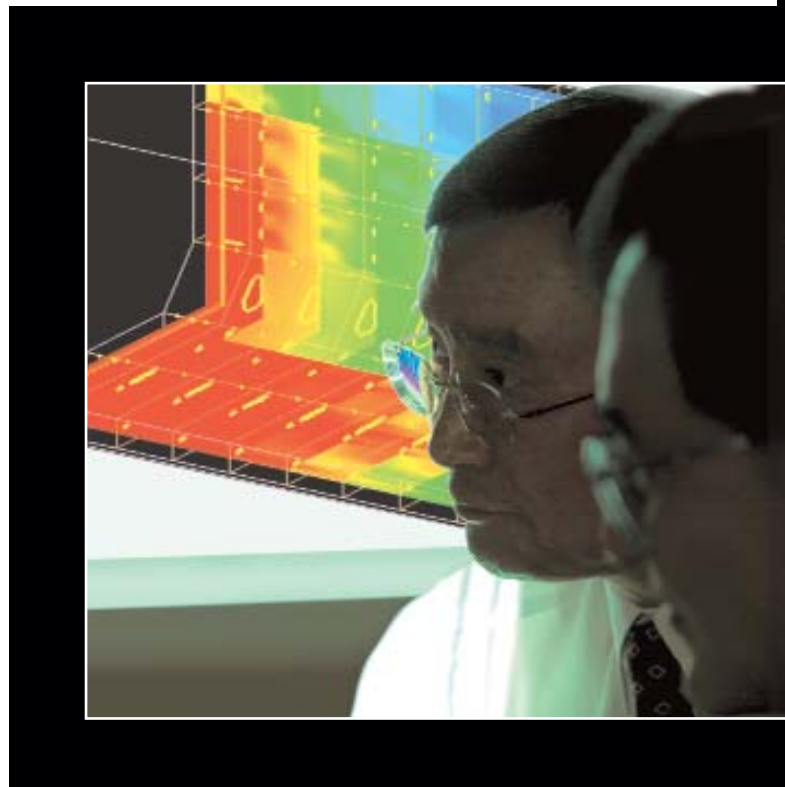

A related project was geared towards identifying the leading indicators of safety failings so that intervening actions could be taken to influence associated risk factors. Focus group sessions were held with crewing experts from industry partners, vetting personnel, safety, health and environmental group personnel and with vessel operating companies' management. Draft guidance for the identification of leading indicators, and an assessment of the extent of validation needed for each was developed.



CLASS ACTIVITY





strong positive trend in classification activity continued in 2004 with the ABS-classed fleet surpassing its record of the previous year, reaching 114.4m gross tons by year-end. ABS remained strong in the core sectors of tankers, bulk carriers and containerships. It also maintained its dominance in the offshore sector securing several notable contracts including two new spars and the Independence Gas Hub production semisubmersible among others.

Aggregate gross tonnage contracted during 2004 remained strong, reflective of continuing high owner demand for ships of all types. The year-end orderbook stood at a healthy 19.3m gt representing a near 15 percent increase of 2.5m gt over a year earlier.

Tanker contracts continued to dominate the new construction orderbook. Both contracts received and the year-end orderbook for new tankers yielded totals that were consistent with those of the prior year. At the close of 2004 ABS retained a market-leading 28 percent of all tankers on order at shipyards around the world.

Year-on-year increases were recorded in the number and gross tonnage of new vessels classed in 2004, in the number of class contracts received during the year for new vessels and the number and tonnage of all vessels on order to ABS class.

The performance left ABS in a sound position to continue this growth in its fleet throughout 2005, after which time the mandated exodus of older, single hull tankers from the market is expected to slow the expansionary trend.

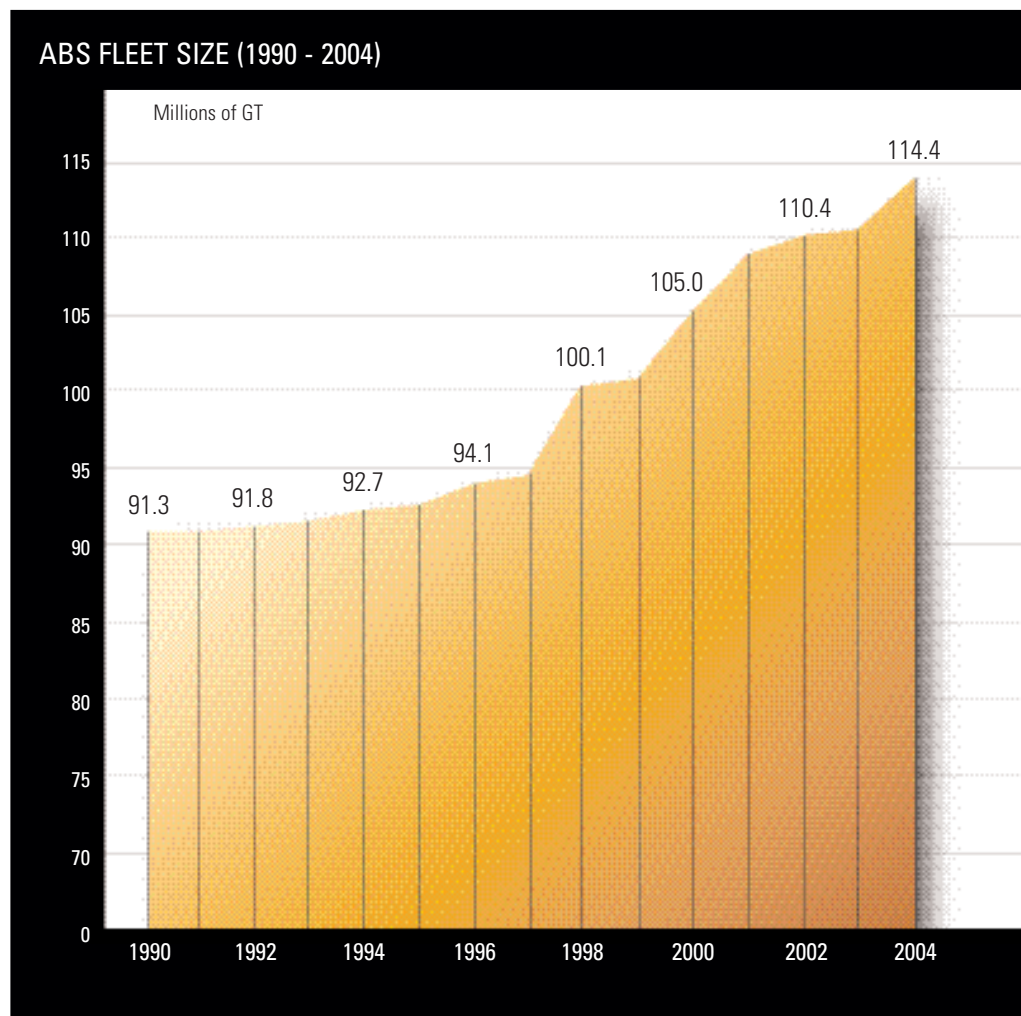

ABS FLEET 2004

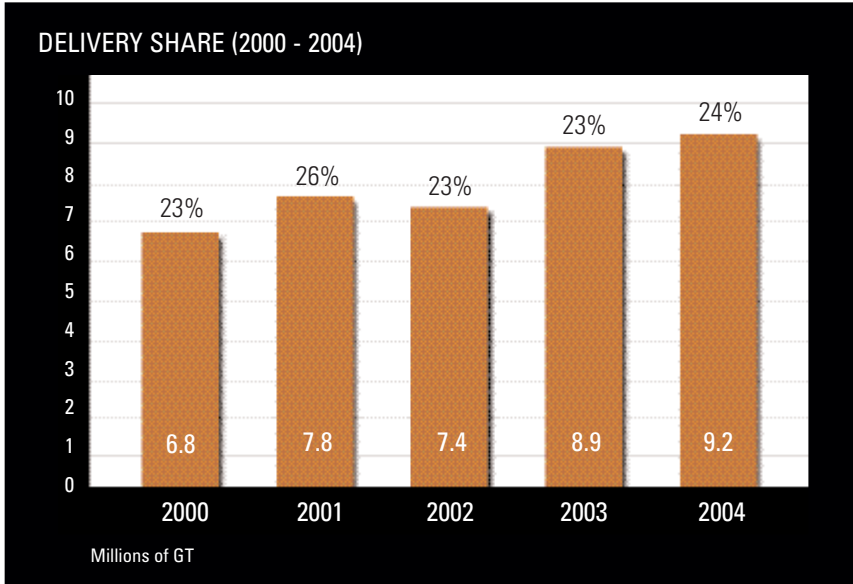

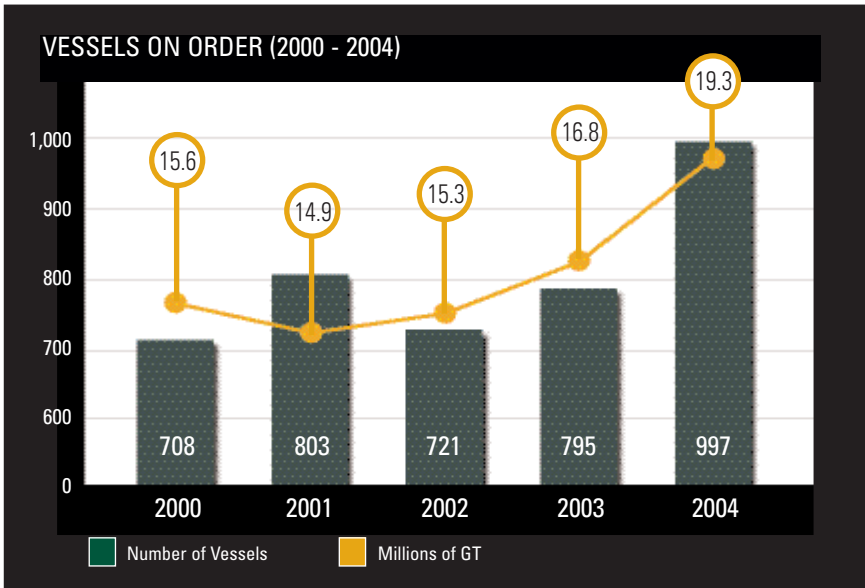
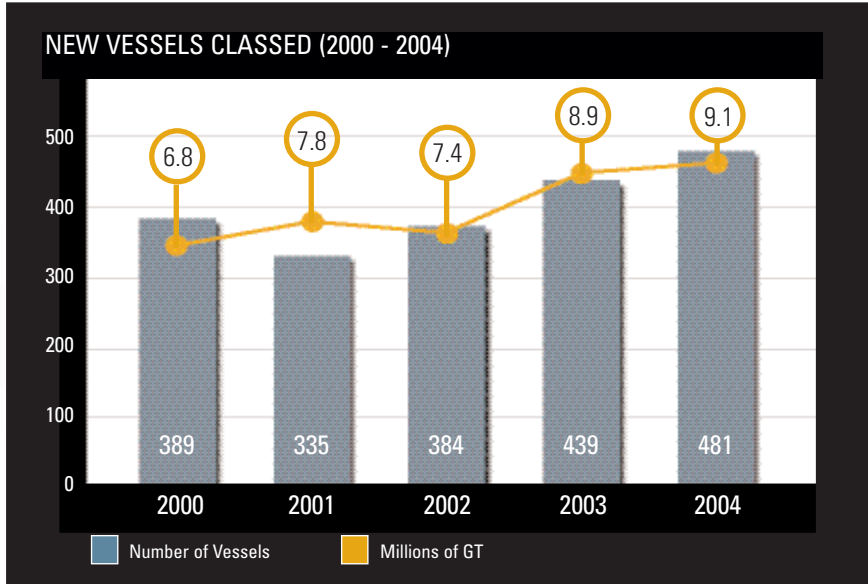

ABS FLEET 2004



SHARE OF WORLDWIDE ORDERBOOK (2004)

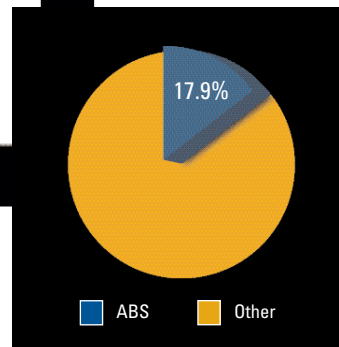
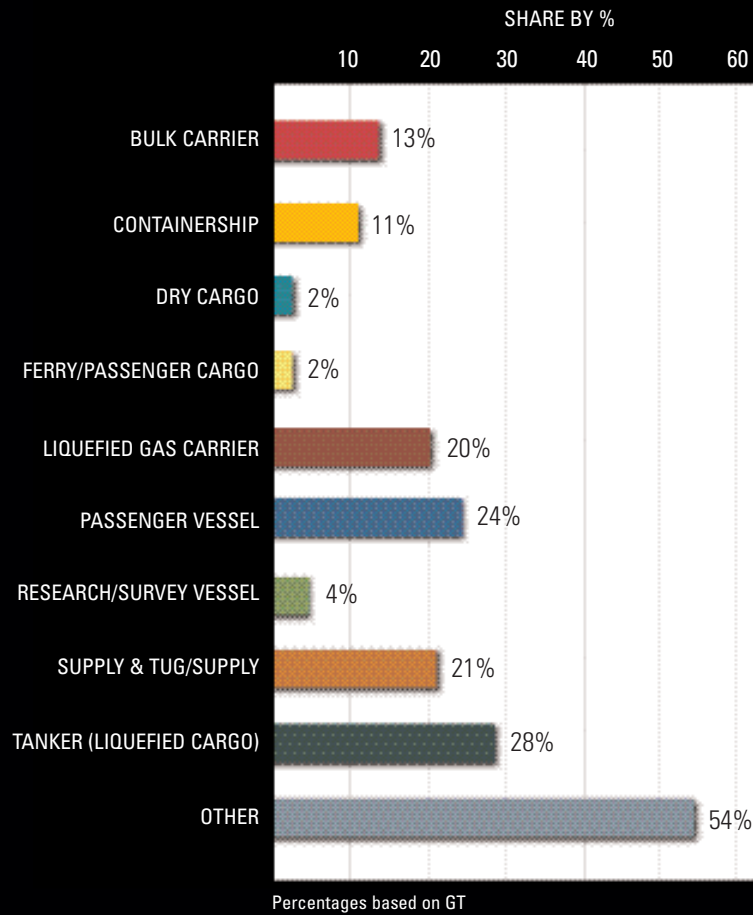



VESSELS REMOVED (2000 - 2004)

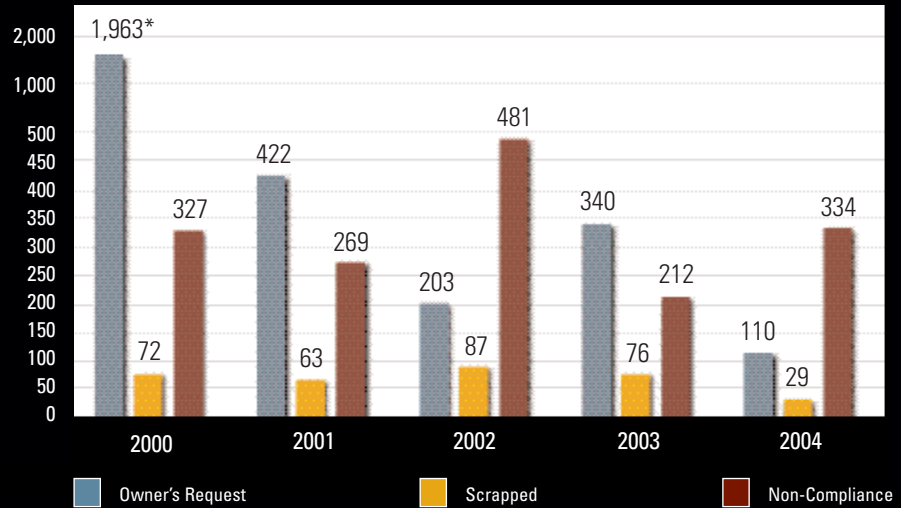

EXISTING FLEET AGE PROFILE

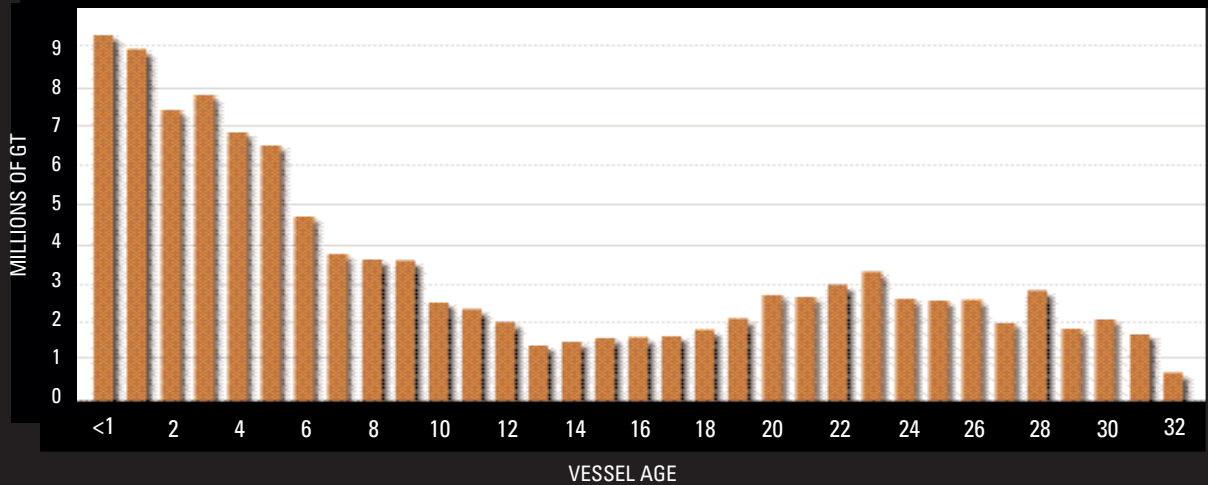

TANKER FLEET 2004

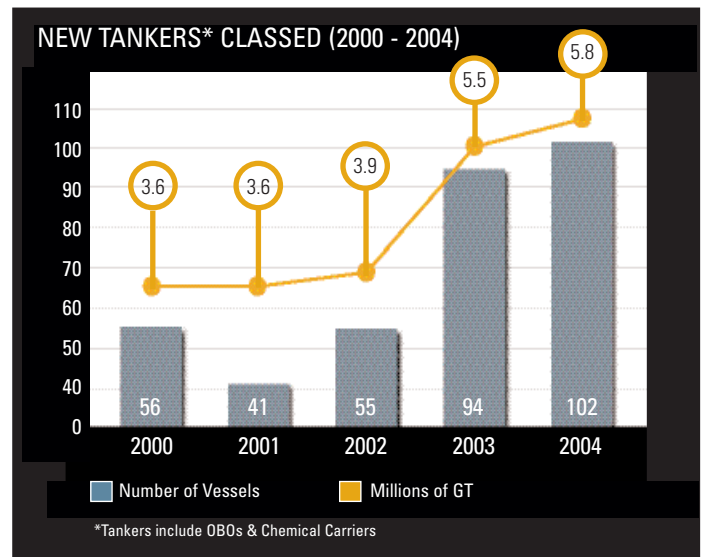
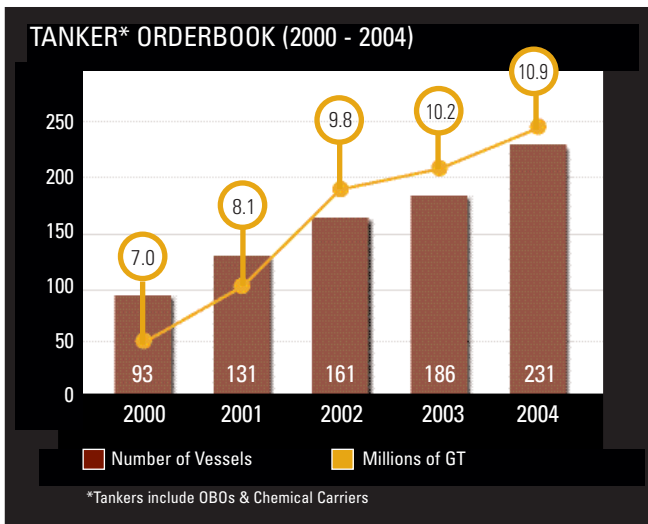
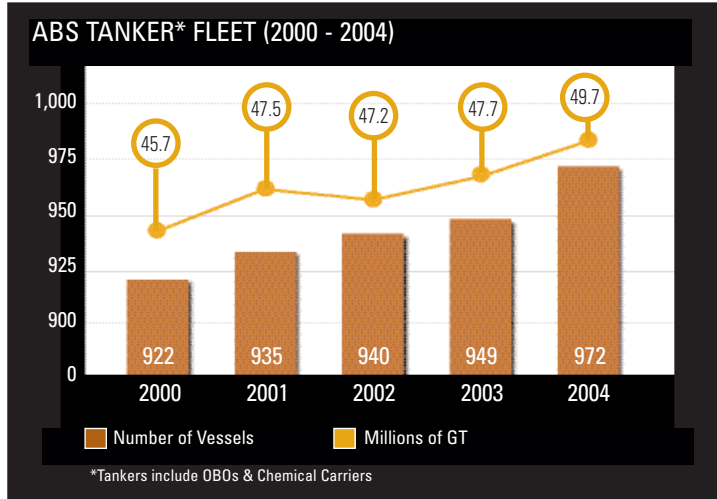

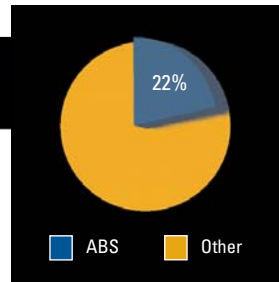
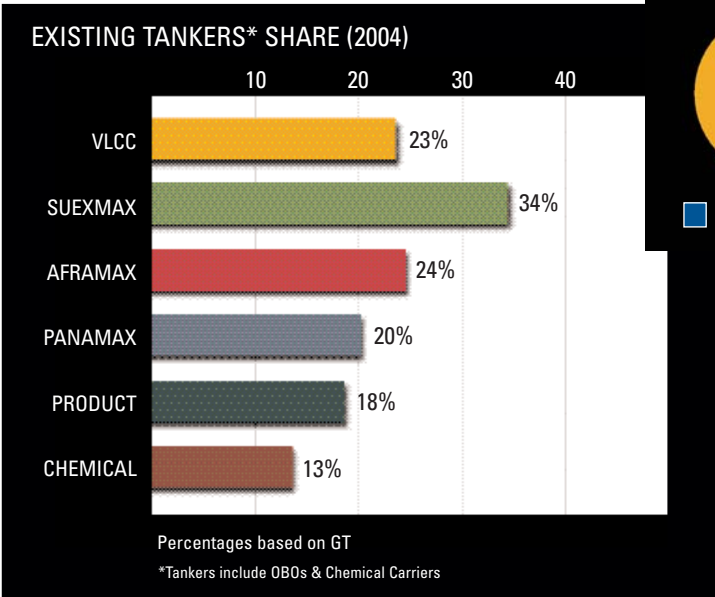
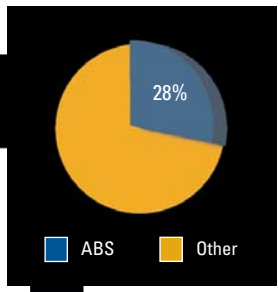
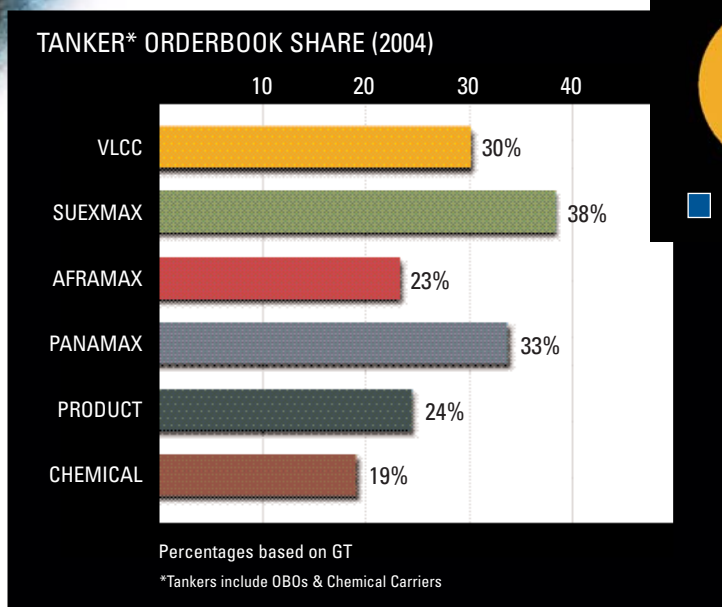

BULK CARRIER FLEET 2004

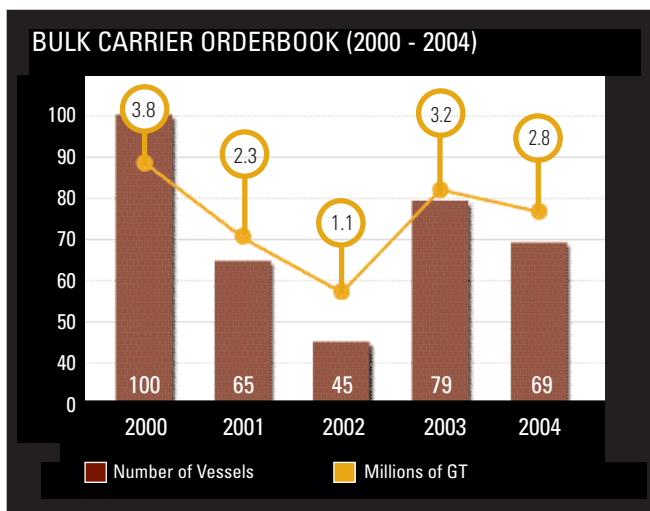
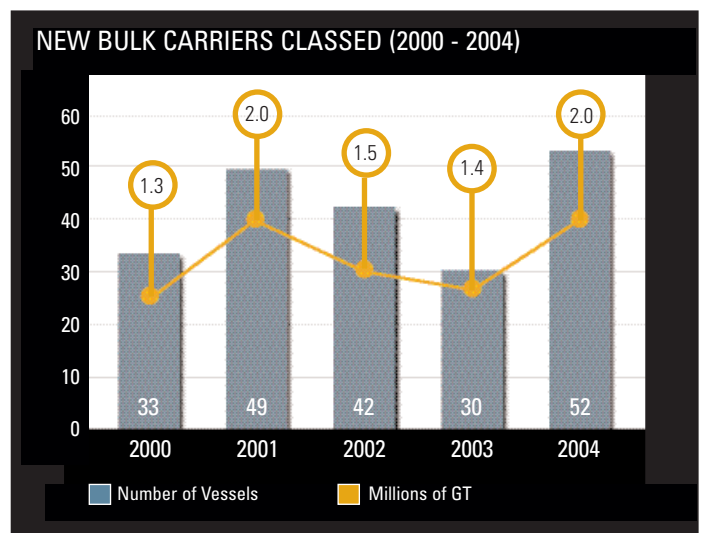
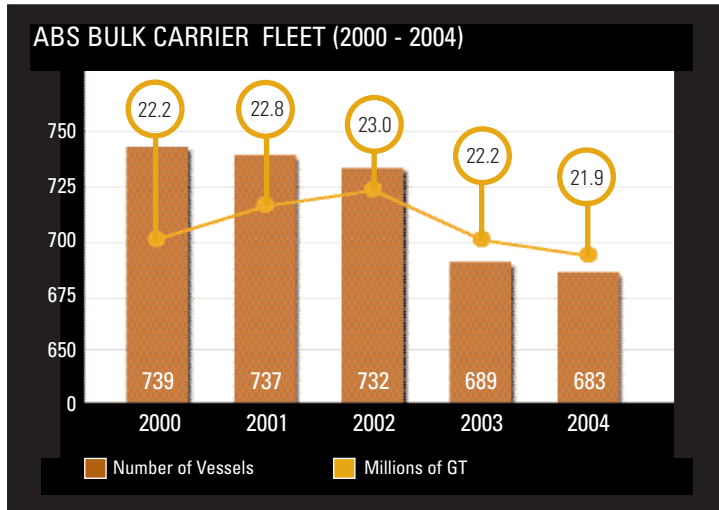



BULK CARRIER ORDERBOOK SHARE (2004)

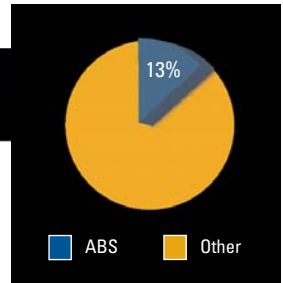
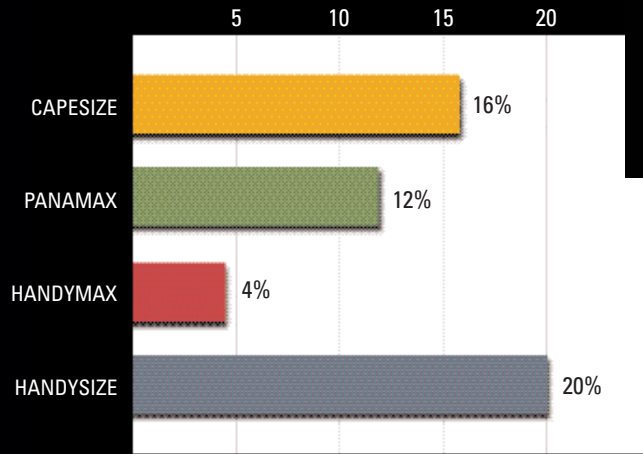

Percentages based on GT

EXISTING BULK CARRIERS SHARE (2004)

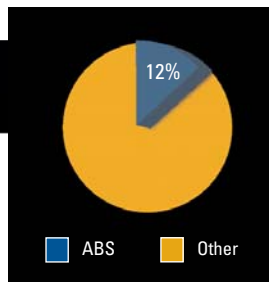
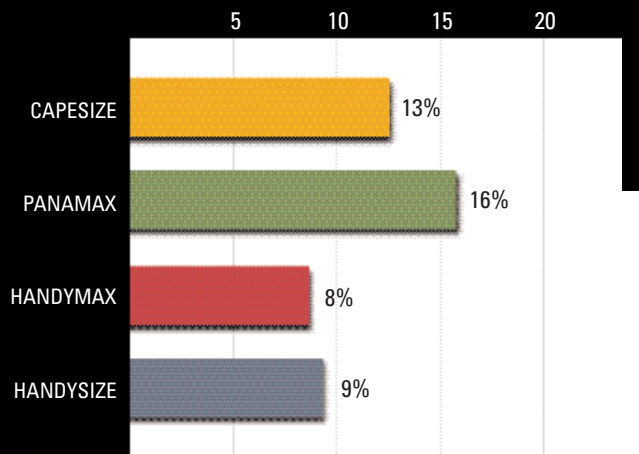

Percentages based on GT



CONTAINERSHIP FLEET 2004

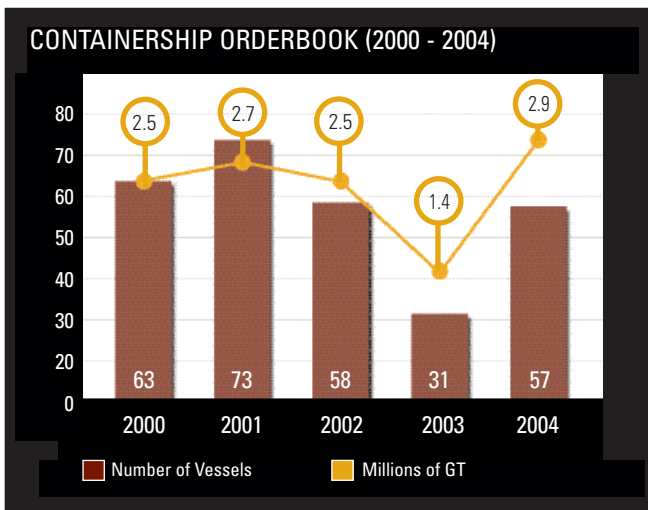
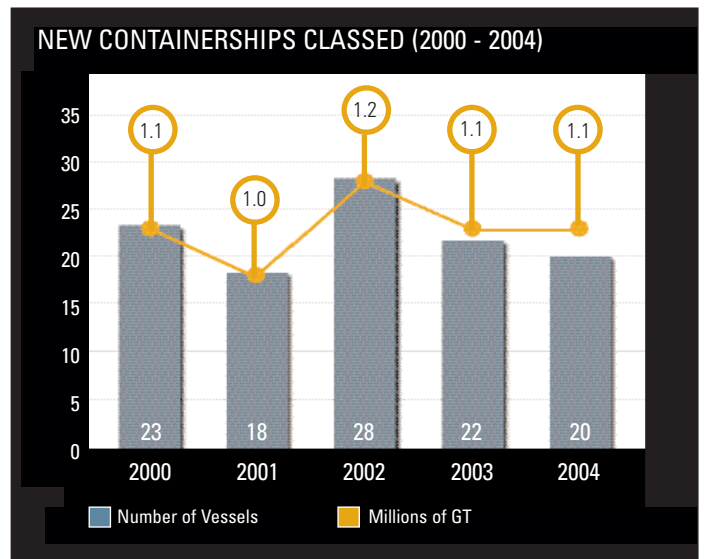
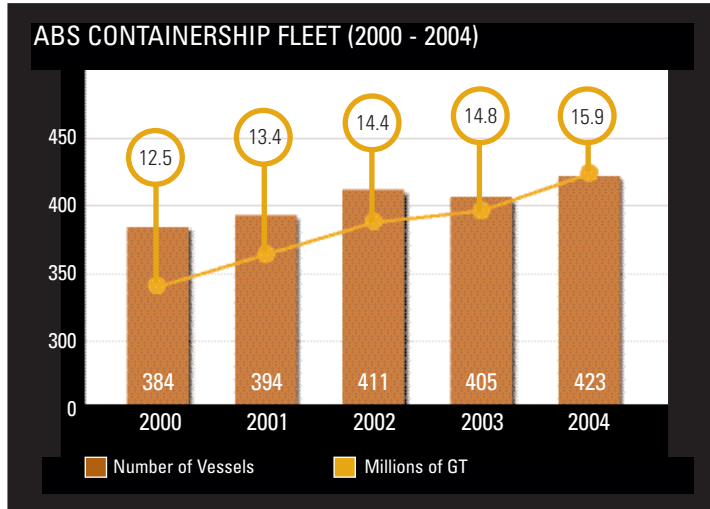

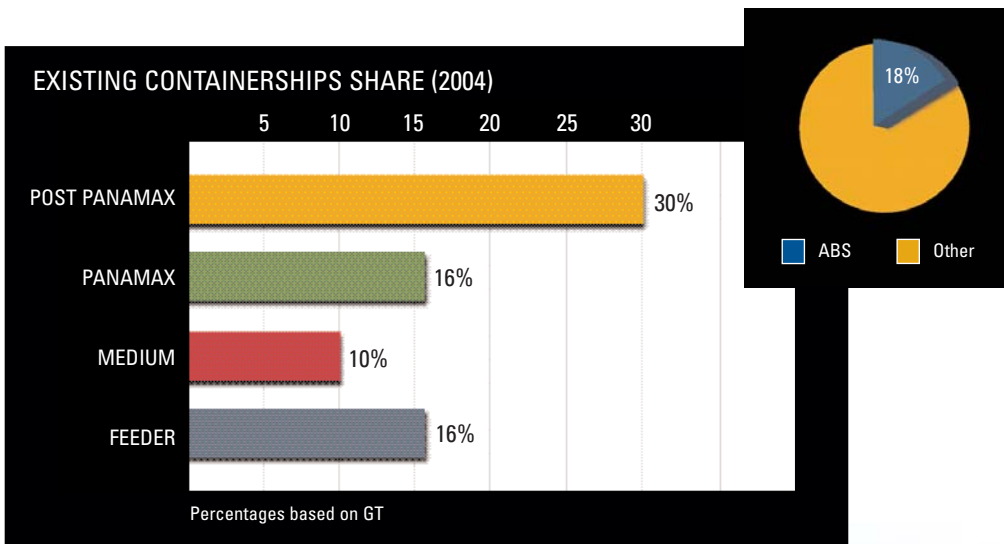
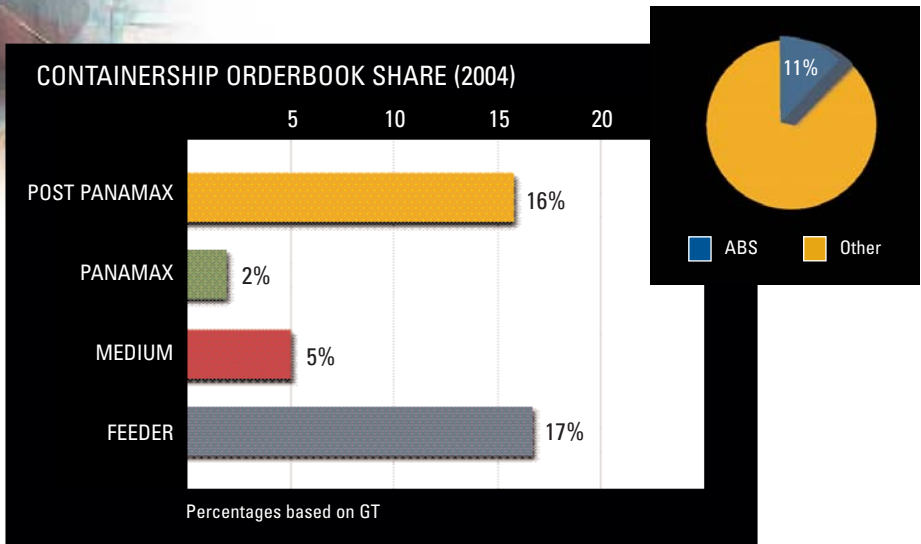

OFFSHORE FLEET 2004



OFFSHORE EXPLORATION UNITS* SHARE (2004)

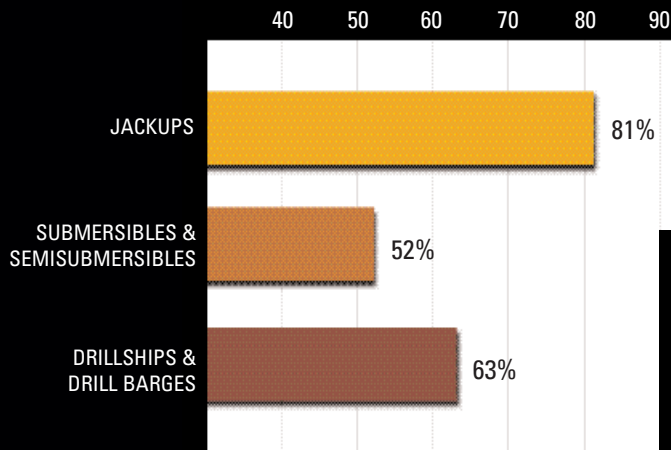

*Classed and/or Certified by ABS

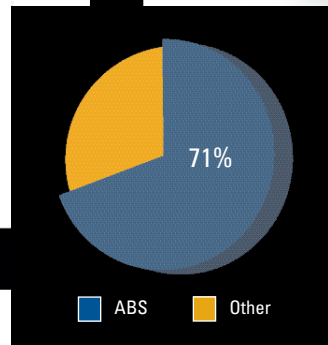

OFFSHORE PRODUCTION UNITS* SHARE (2004)

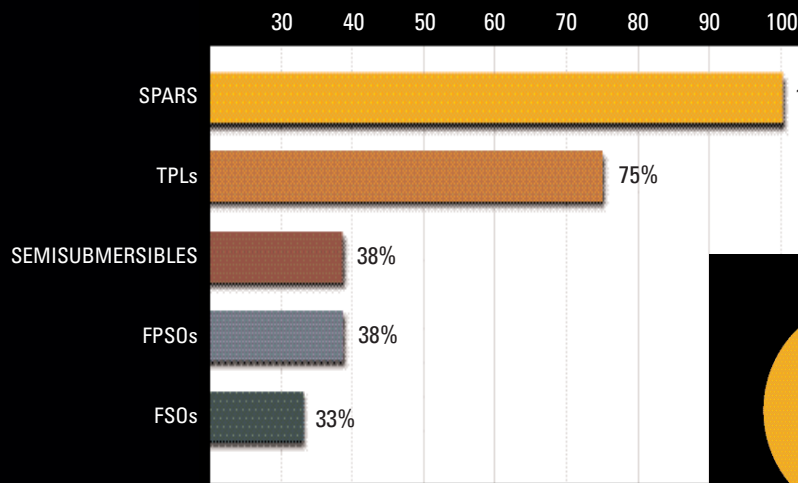

*Classed and/or Certified by ABS

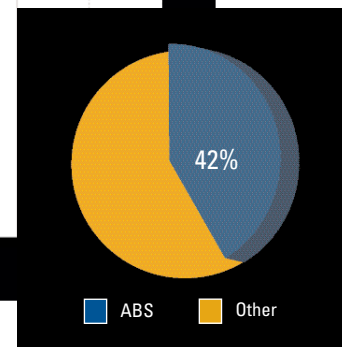

VESSEL TYPE	Vessels in Class as of 31 Dec 2004		Vessels on Order as of 31 Dec 2004		New Vessels Classed During 2004	
	NO.	GROSS TONS	NO.	GROSS TONS	NO.	GROSS TONS
Barge	1,608	4,378,499	148	432,161	88	221,035
Barge Carrier	11	280,075	1	3,101	6	6,264
Bulk Carrier	676	21,803,534	69	2,823,671	52	2,110,566
Bulk Liquid Carrier	11	40,614	0	0	0	0
Chemical Carrier	159	3,391,251	61	1,087,638	0	0
Column Stabilized Unit	144	2,068,062	0	0	1	20,620
Container Carrier	423	15,899,890	57	2,932,368	16	1,016,238
Dredge	44	118,660	2	10,650	0	0
Drillship	22	581,264	1	112,500	0	0
Ferry	89	924,351	9	8,970	1	5,901
Fishing Vessel	22	38,765	3	1,064	0	0
Fixed Platform	144	26,917	1	4,745	14	0
Floating Dry Dock	18	86,862	1	3,808	2	27,520
General Cargo Carrier	348	3,153,146	5	33,845	0	0
Heavy Lift Ship	4	63,304	0	0	1	2,509
High Speed Craft	102	57,395	52	14,236	24	5,226
Independent Tank Barge	7	11,343	0	0	0	0
Lash Barge	319	65,360	0	0	0	0
Liquefied Gas Carrier	70	3,227,315	12	1,153,144	2	186,154
Liquefied Gas Tank Barge	4	1,296	1	1,000	0	0
Offshore Racing Yacht	1	49	0	0	0	0
Offshore Supply Vessel	974	854,645	32	34,000	36	61,223
Offshore Support Vessel	74	150,151	38	66,900	0	0
Oil Carrier	798	46,165,375	170	9,805,429	94	5,237,950
Oil or Bulk/Ore (OBO) Carrier	4	123,171	0	0	0	0
Ore Carrier	7	114,220	0	0	0	0
Passenger Vessel	49	444,466	45	361,499	1	42
Refrigerated Cargo Carrier	21	235,556	0	0	2	37,862
Self Elevating Unit	336	1,970,681	15	638	6	68,557
Single Point Mooring	42	100	0	0	2	0
Spar	12	0	2	0	2	0
Special Purpose Vessel	615	1,166,038	29	155,218	4	4,127
Subsea Pipeline	8	0	0	0	0	0
Swath Vessel	8	24,972	0	0	0	0
Tank Barge	435	2,263,318	30	183,454	22	66,793
Tension Leg Platform	9	0	0	0	0	0
Towboat	3	571	0	0	0	0
Tug	1,044	387,019	107	60,653	52	41,045
Underwater Systems	46	9,627	2	4,206	0	0
Vehicle Carrier	109	4,105,446	3	16,365	0	0
Yacht	410	116,778	98	19,295	52	16,708
Not Specified	0	0	3	2,184	1	0
TOTAL	9,230	114,350,086	997	19,332,742	481	9,136,340

ABS CORPORATE OFFICERS

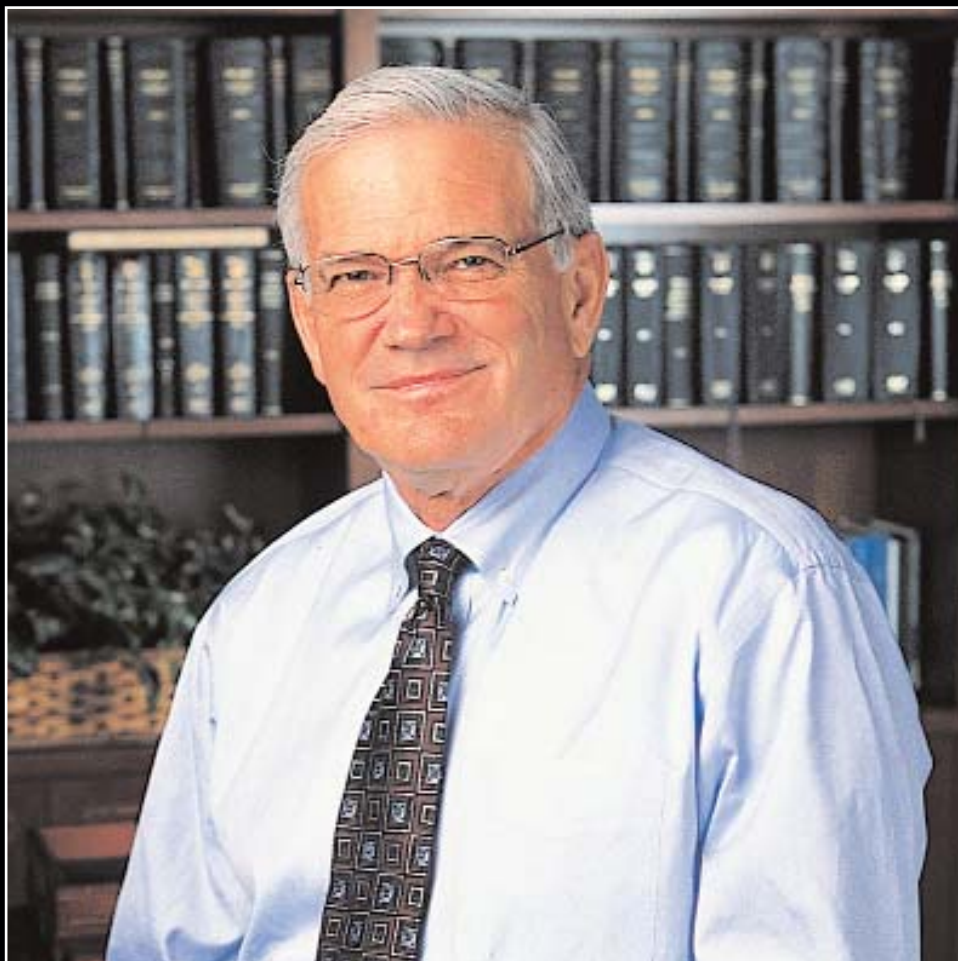

Robert D. Somerville
Chairman &
Chief Executive Officer



Christopher J. Wiernicki
Executive Vice President &
Chief Technology Officer



T. Ray Bennett
Vice President



Antonio C. Lino Costa
Vice President,
Division President - ABS Europe



Thomas A. Miller
Vice President,
General Counsel & Secretary



Linwood (Lenny) Pendexter
Vice President &
Chief Surveyor



Vincent F. (Bud) Roth
Senior Vice President
& Chief of Staff

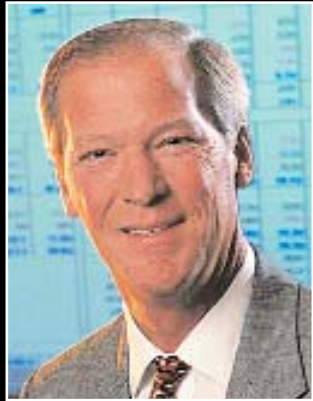

Robert J. Bauerle
Senior Vice President
Treasurer & Chief Financial Officer



James C. Card
Senior Vice President

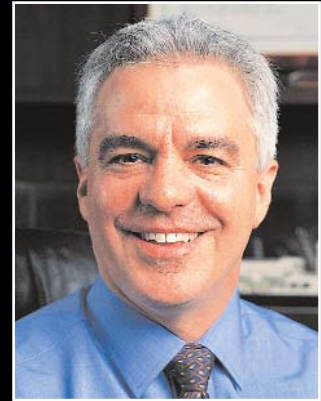

Gary A. Latin
Senior Vice President &
Chief Information Officer



Todd W. Grove
Vice President,
Division President - ABS Americas



James B. Liebertz
Vice President,
Division President - ABS Pacific



Robert E. Kramek
President &
Chief Operating Officer

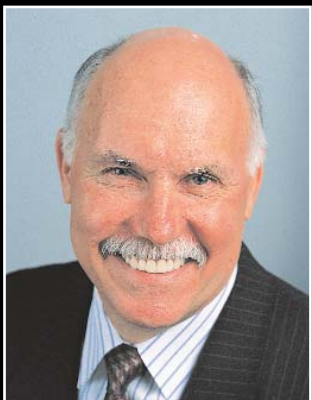

William J. Sember
Vice President



Stewart H. Wade
Vice President

ABS BOARD OF DIRECTORS

Michael L. Carthew
ChevronTexaco Shipping
Company LLC

Richard D. DeSimone
St. Paul Travelers Companies

Peter George Goulandris
Capeside Steamship
Company Ltd.

John A. Hickey

John R. Huff
Oceaneering International, Inc.

Robert E. Kramek
ABS

Gerhard E. Kurz
Seabulk International Inc.

Joseph Kwok
American Eagle Tankers
Inc. Ltd.

Dr. Donald Liu

Robert D. Somerville
ABS

Dean E. Taylor
Tidewater, Inc.

Douglas C. Wolcott
Wolcott Associates

ABS COUNCIL

Ibrahim M. Al-Ghanim
Kuwait Oil Tanker Co. S. A. K.

Kurt Andersen*

John A. Angelicoussis
Anangel Maritime Services Inc.

Robert J. Bauerle
ABS

William T. Bennett Jr.
Bennett & Associates, LLC

Francis Blanchelande
Single Buoy Moorings (SBM)
Production Contractors

James C. Card
ABS

Lars Carlsson

John M. Carras*
Carras (Hellas) S.A.

Michael L. Carthew
ChevronTexaco Shipping
Company LLC

Kuo-Cheng Chang
Evergreen Group

T. H. Chen
Yang Ming Marine
Transport Corp.

Choo Chiau Beng
Keppel Offshore & Marine Ltd.

Admiral Thomas H.
Collins
U.S. Coast Guard

John G. Coumantaros
Southern Star Shipping Co., Inc.

Thomas B. Crowley Jr.
Crowley Maritime Corp.

Ing. Cesare d'Amico
D'Amico Societa' di
Navigazione S.p.A.

James C. Day
Noble Drilling Corp.

Robert A. DeMotta
Aon Risk Services

Richard D. DeSimone
St. Paul Travelers Companies

Richard T. du Moulin
Intrepid Shipping LLC

Dimitrios J. Fafalios
Fafalios Ltd.

John D. Fafalios*
Fafalios Ltd.

Peter R. Goodfellow

Peter George Goulandris
Capeside Steamship
Company Ltd.

Dott. Aldo Grimaldi
Grimaldi Group

Bengt Hermelin
Samco (Services) Ltd.

John A. Hickey

Michael S. Hudner
B & H Management, Ltd.

John R. Huff
Oceaneering International, Inc.

Yung Won Hyun*
Hyundai Merchant
Marine Co., Ltd.

Frank J. Iarossi
ABS Group of Companies, Inc.

Paul J. Ioannidis*
Alexander S. Onassis
Foundation

William E. Jenkins SeaRiver Maritime, Inc.	Sanjay Mehta Essar Shipping Ltd.	Robert D. Somerville ABS
Capt. Robert E. Johnston OSG Ship Management, Inc.	Thomas A. Miller ABS	Capt. Cesare Sorio SJ Marine Inc.
Capt. Spyros N. Karnesis European Navigation Inc.	C. R. (Bob) Palmer	Prabhat Kumar Srivastava The Shipping Corporation of India Ltd.
Robert E. Kramek ABS	Stephen Y. K. Pan World-Wide Shipping Agency Limited	Craig H. Stevenson Jr. OMI Corporation
Charles Kurz II Keystone Shipping Co.	Pericles S. Panagopulos Superfast Ferries S.A.	Dean E. Taylor Tidewater, Inc.
Gerhard E. Kurz Seabulk International Inc.	Basil Phrixos Papachristidis Hellasport Steamship Corp. Monrovia	Nikolas P. Tsakos Tsakos Energy Navigation Limited
Joseph Kwok American Eagle Tankers Inc. Ltd.	Linwood A. (Lenny) Pendexter ABS	Frank W. K. Tsao* IMC Development & Management Ltd.
John P. Laborde*	Ambassador Manoel Pio Correa Jr.* Infrapart Consultants	Michael D. Tusiani Poten & Partners, Inc.
Gary A. Latin ABS	Spyros M. Polemis Seacrest Shipping Company Ltd.	Capt. Antonio J. Valdes ConocoPhillips, Inc.
James B. Liebertz ABS	Robert E. Rose GlobalSantaFe Corp.	Richard H. Vortmann National Steel & Shipbuilding Company
David T. E. Lim Neptune Orient Lines Ltd.	Dott. Alcide Ezio Rosina* Premuda S.p.A. di Navigazione	Rod Vulovic U.S. Ship Management, Inc.
Antonio C. Lino Costa ABS	Vincent F. (Bud) Roth ABS	Stewart H. Wade ABS
Dr. Donald Liu	Basil C. Scarvelis Trident Maritime Agency, Inc.	Capt. Wei Jiafu China Ocean Shipping Group Co.
Peter G. Livanos Ceres Hellenic Shipping Enterprises Ltd.	Capt. William G. Schubert US Maritime Administration	Douglas C. Wolcott Wolcott Associates
Dr. Frank F. H. Lu Yang Ming Marine Transport Corp.	William J. Sember ABS	James A. Zrebiec International Marine Underwriters/OneBeacon
Dr. John J. McMullen* McMullen Consultants Inc.	Philip J. Shapiro Liberty Maritime Corporation	

**Emeritus Council Member*

ABS WORLDWIDE LOCATIONS

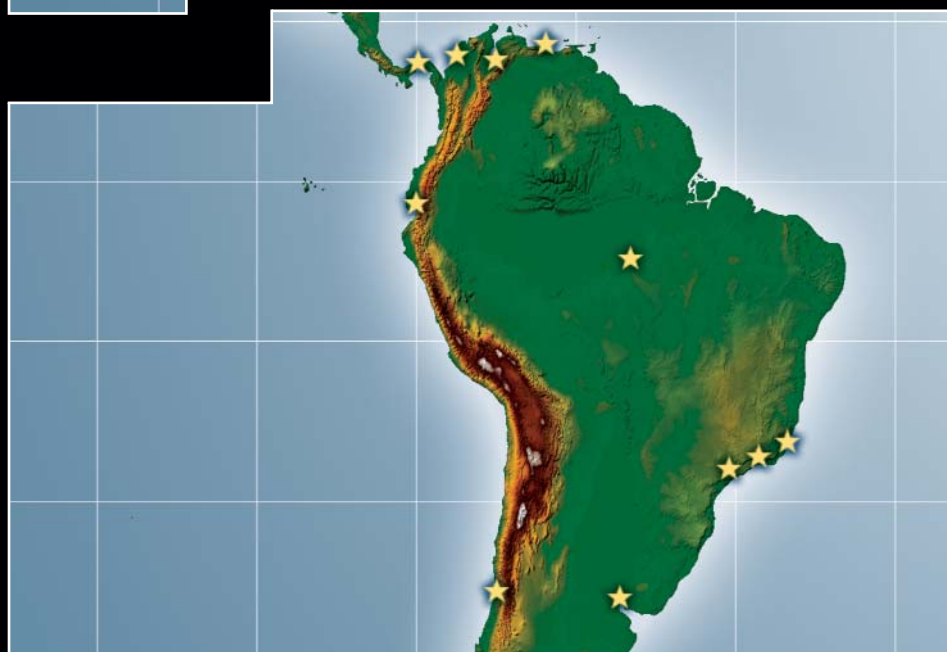

Produced by:
ABS Marketing Development & Communications
Houston, TX USA



THIS ANNUAL REVIEW IS PRINTED ON RECYCLED PAPER
CONTAINING RECOVERED, POST-CONSUMER WASTE PAPER

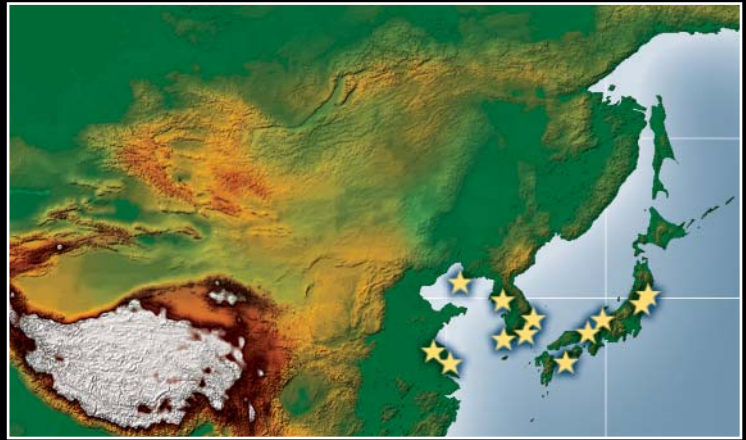

ABS PLAZA
16855 NORTHCHASE DRIVE • HOUSTON, TX 77060 USA
TEL: 1-281-877-5800 • FAX: 1-281-877-5803 • EMAIL: abs-worldhq@eagle.org
www.eagle.org